



CITY OF
Alexandria
VIRGINIA

AFFORDABLE HOUSING

The Case for Passive House Design and Net Zero Energy



ONION
FLATS

Tim McDonald

tim@onionflats.com

215.783.5591

VERTICALLY INTEGRATE



1997



2022

-



**1-39 Hano St
Boston, MA**

20 units, Passive House, NZE
RMI: REALIZE Retrofit Program



**Lake House
Thompson, PA**

Single Family home, Passive House, NZE



**Rust House
Phila, PA**

Single Family home, Passive House

CURRENT + RECENT PROJECTS



**Copper Flats
Phila, Pa**

88 units, Passive House, NZE



**Morris Steel
Phila, PA**

692 units, Passive House, NZE



**Mercill Flats
Jackson Hole, WY**

30 units, Passive House, NZE



**Mermaid Lane
Phila, PA**

280 units, Passive House, NZE



1600 North St
Baltimore, MD
17 units, Passive House, NZE



Snow King
Jackson Hole, WY
24 units, Passive House, NZE



Fairmount Commons
Newark, NJ
24 units, Passive House, NZE



Rhodia
Louisville, KY
600 units, Passive House, NZE



Parade St. Commons
Erie, PA
40 units, Passive House, NZE



Vine St NZE
Philadelphia, PA
220 units, Passive House, NZE



Radwyn Housing
Radwyn, PA
48 units, Passive House, NZE



and contribute

45%

of U.S. GHG emissions

EIA 2012

Carbon dioxide equivalent emissions from the City's 2015 GHG Inventory

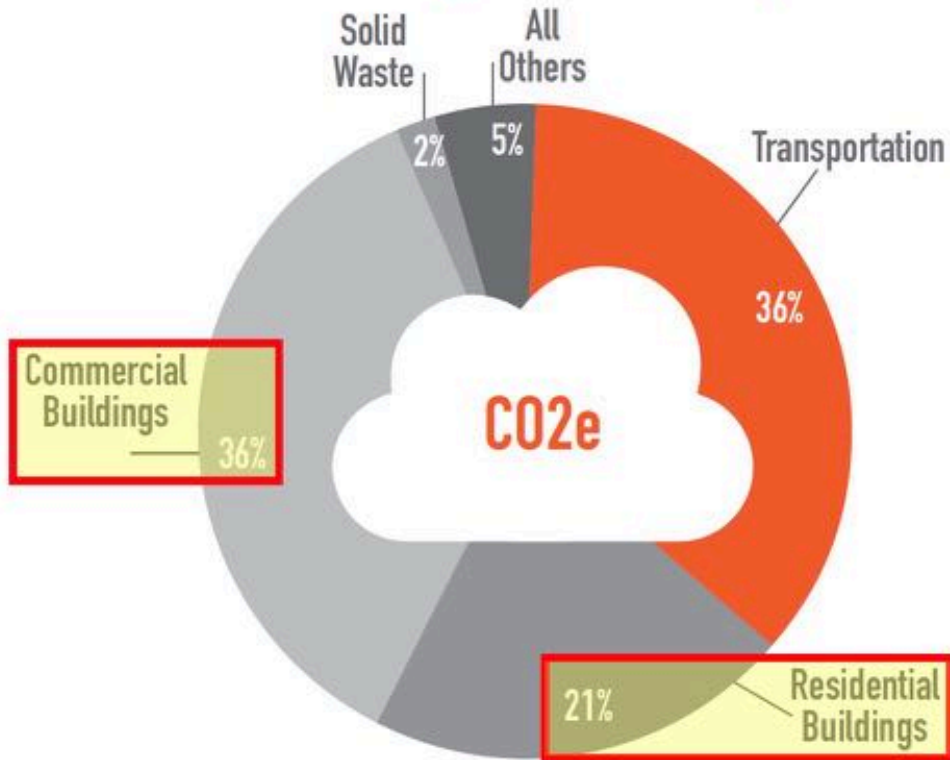

BUILDINGS IN ALEXANDRIA
account for

57%
of all GHG



City of Alexandria

ENVIRONMENTAL ACTION PLAN 2040



Preface

The City recognizes the urgent need for City-wide environmental planning because of the changing climate as indicated by increased carbon dioxide in the atmosphere, extreme weather events, rising coastal waters, and record-breaking rainfall and high temperatures.

Alexandria has been a Virginia Municipal League leader in regional sustainability for 11 years in the Go Green Virginia challenge, a recognition of local government programs and policies to promote sustainability at the highest level. This new Environmental Action Plan 2040 (EAP 2040) for sustainability builds on the 2008 Eco-City Charter and the Environmental Action Plan 2030 (EAP 2030) adopted in 2009. The EAP 2040 covers the same ten topic areas as the original plan with updates on what has been achieved and new action recommendations to further advance sustainability in the City.

The City has achieved a per capita emission reduction of 22 percent for the 2015 emission inventory over the 2005 base year by completing or adopting, as an ongoing initiative, a majority of actions in the EAP 2030 policy plan. The most significant achievement was closing the coal-fired power plant in 2012 well ahead of the target date. Other achievements are highlighted in each section introduction, as well as a summary document in the appendix, and on the Eco-City webpage.

This new EAP 2040 plan is focused on climate change mitigation and adaptation. The plan actions are focused on local priorities and includes order-of-magnitude cost estimates, relative impactfulness, and references to related documents with more detailed guidance or policy. The plan recognizes the need to include environmental impact as a tool for decision making. New metrics can help identify related impacts from actions in other topic sections. For example, transitioning to electric vehicles both improves energy efficiency and local air quality.



Because commercial and residential buildings, businesses and personal transportation account for 96 percent of greenhouse gas (GHG) emissions, a successful plan means people must participate and make sustainability changes. Challenges include engaging the community into action, fiscal constraints of budget and staff resources, time constraints, and legal authority within the Commonwealth. There are other challenges to achieving aggressive goals and targets including the need for state and federal leadership in the areas of

legislative support for renewable energy development, minimum efficiency standards, and providing financial assistance.

At a high level, the goals and targets of the City are to exceed regulatory minimums, achieve carbon neutrality by 2050 and provide better tracking and performance. To be successful, everyone in the City will have to take action, make sustainable choices, do their fair share, and work together to truly make Alexandria a more sustainable Eco-City in which to live, work, and play.



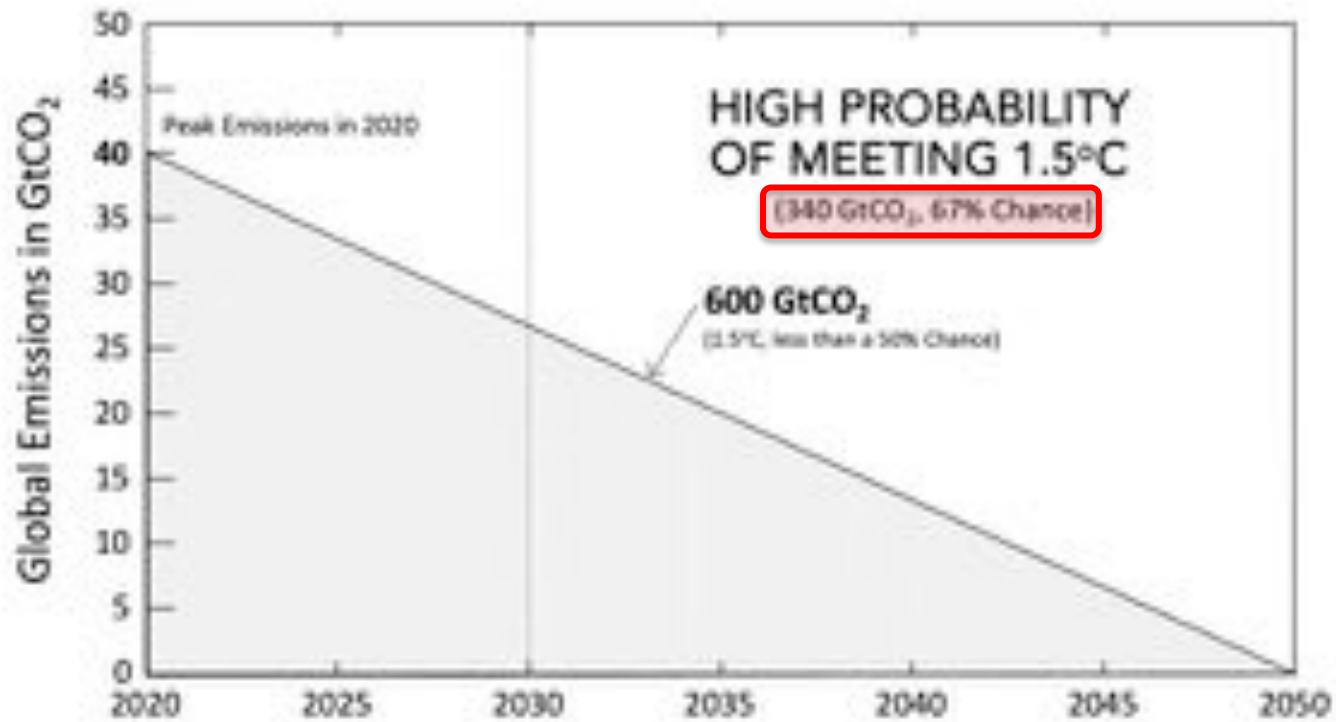

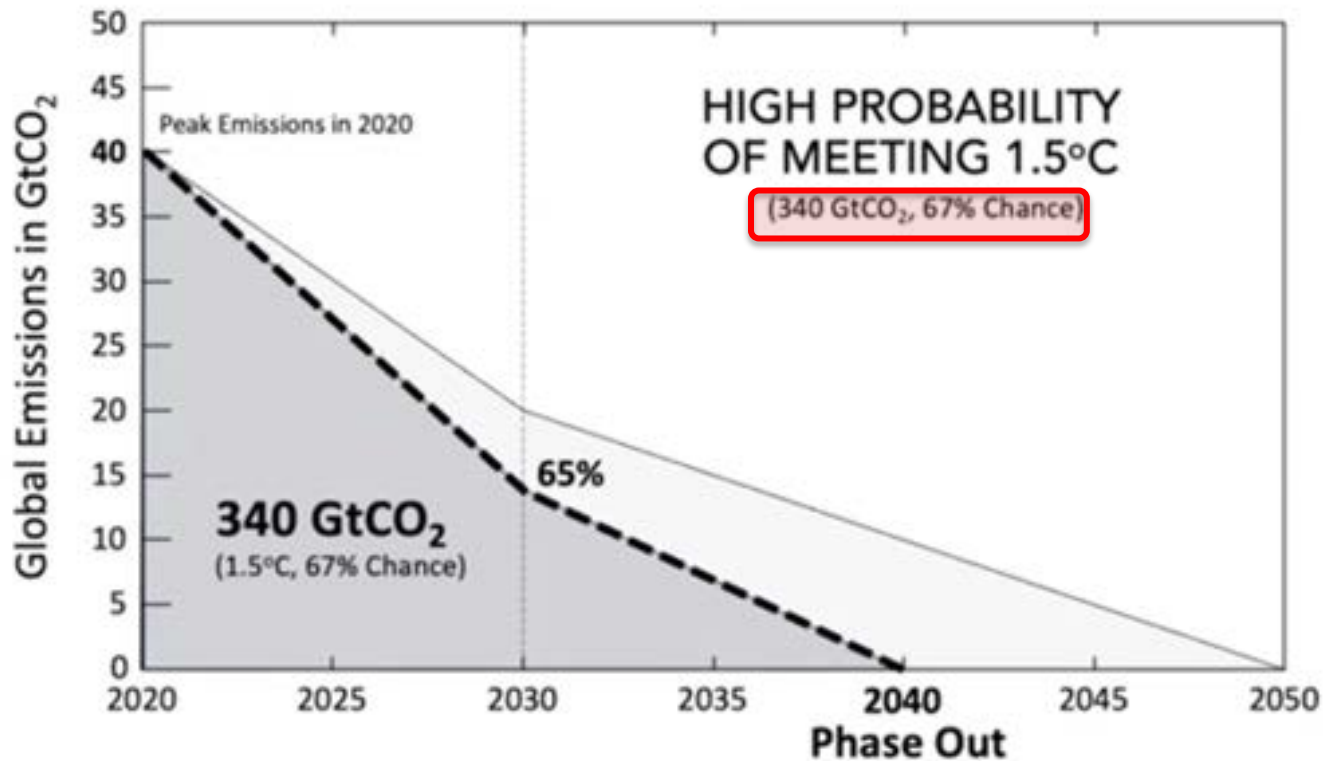

CARBON NEUTRAL/NZE BUILDINGS by 2040

BUILDINGS MUST GENERATE WHAT THEY NEED
CARBON NEUTRAL/NZE BUILDINGS by 2040
ON THEIR OWN SITE

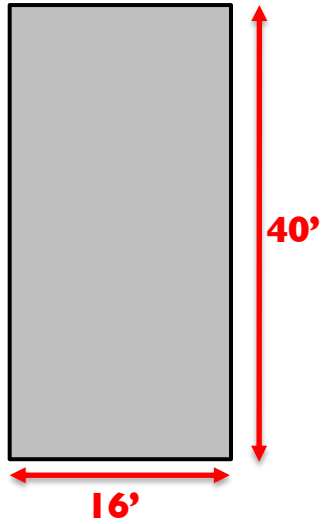

1900 sf home
39,000 kWh/yr

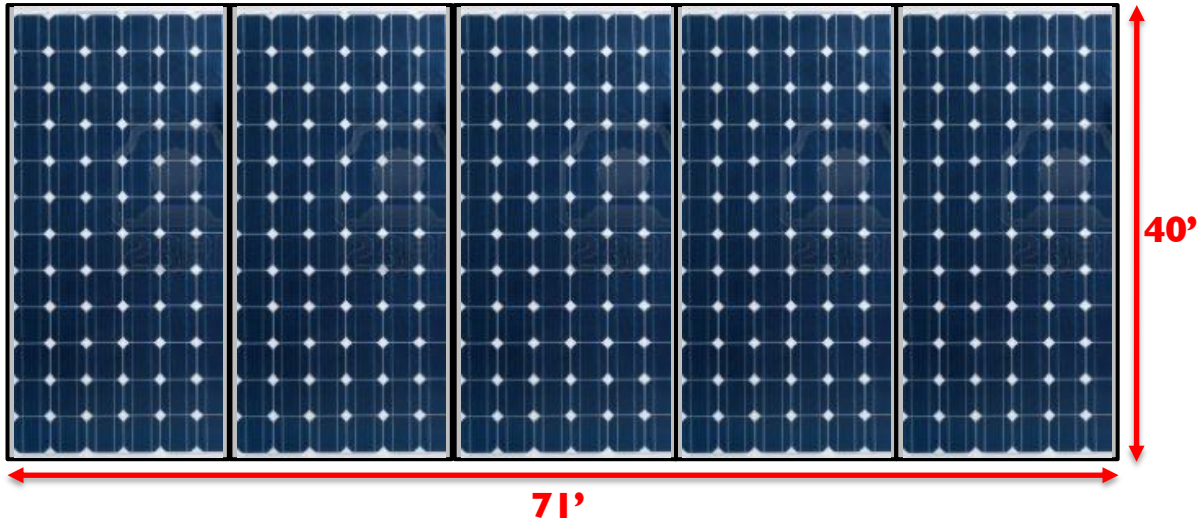

1900 sf home
39,000 kWh/yr
2832 sf roof



40'

16'



80% REDUCTION

4.5 kWh/sf/yr

8550 kWh/yr

615 sf roof

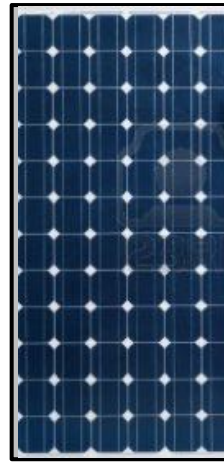
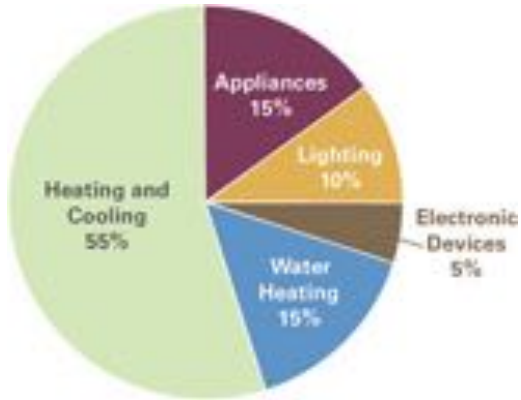

16'

40'



80% REDUCTION

4.5 kWh/sf/yr

8550 kWh/yr

615 sf roof

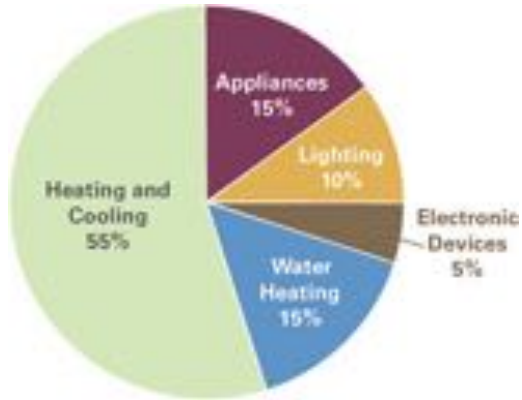

40'

16'

80% REDUCTION

4.5 kWh/sf/yr

8550 kWh/yr

615 sf roof





**“Fabric First”
approach**



40'

16'



80% REDUCTION

4.5 kWh/sf/yr

8550 kWh/yr

615 sf roof

Envelope and Thermal Comfort Principles

1. **Continuous Insulation**- creating steady indoor temperatures that won't drop below 50 degrees without heating source
2. **Thermal Bridge Free Construction**- minimizes condensation/ building deterioration
3. **Compact Building Shape**- excellent surface-to-volume ratio (< 1)
4. **Airtightness**- minimizes moisture diffusion into wall assembly
5. **Balanced Ventilation with Heat Recovery with minimal Space Conditioning System** - exceptional efficiency, indoor air-quality and comfort
6. **Optimal Solar Orientation and Shading**
— maximizing solar gains for winter, minimizing gains for the summer case

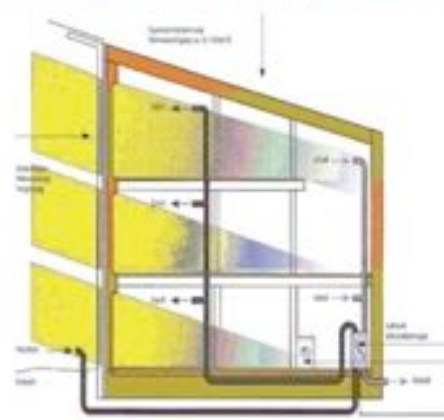

7. **Energy Efficient Appliances and Lighting**- highly efficient use of household electricity
8. **User Friendliness** - user manuals are recommended to be given homeowners



STABLE FLATS 2015: 26 townhomes

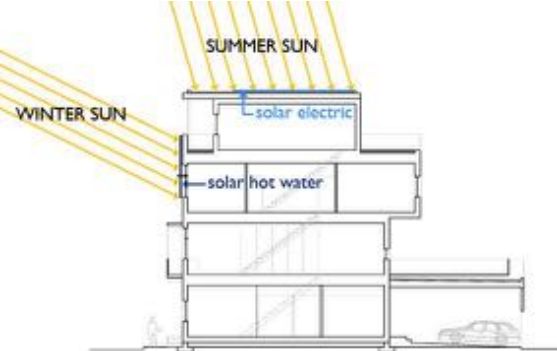

INNOVATE PREFABRICATE











INTEGRATE



MAKE IT TIGHT VENT IT RIGHT



ENERGY/BUILDING CONSULTANTS & ENGINEERS

One Crescent Drive • Philadelphia, PA 19112 • 1-888-MAGGRANN • www.magrann.com

New Jersey • Pennsylvania • Kentucky • Ohio

BUILDING LEAKAGE TEST COMPARISON

FINAL AIRFLOW

.49 ACH 50

Test #1	Test #2
Test File: Depressurization File	Test File: Pressurization File
Date of Test: 7/5/2012	Date of Test: 7/5/2012
Customer: Orion Flats, LLC 111 West Norris Street Philadelphia, Pennsylvania 19122	Customer: Orion Flats
Phone: 215-783-5591	

Test Results

	Test #1	Test #2	Change	Percent
1. Airflow at 50 Pascals	293 CFM 6.48 ACH	201 CFM 6.33 ACH	-92 CFM -0.15 ACH	-31.4 % -31.4 %





\$150.00 sf

** 12 Months of Measured Data*

Address	TFA sf	12 Months kWh Total	PV kWh	NET	COST \$/Yr
235 George	1908	13,088	4172	8916	\$1079 \$90/m
Typical Code Building		40,068		68% BETTER	\$4407 \$367/m

PHASE 1
THE FACTORY
1999

PHASE 2
THIN FLATS
2008

PHASE 3
THE BATTERY
2017

PHASE 3: **THE BATTERY** 2017

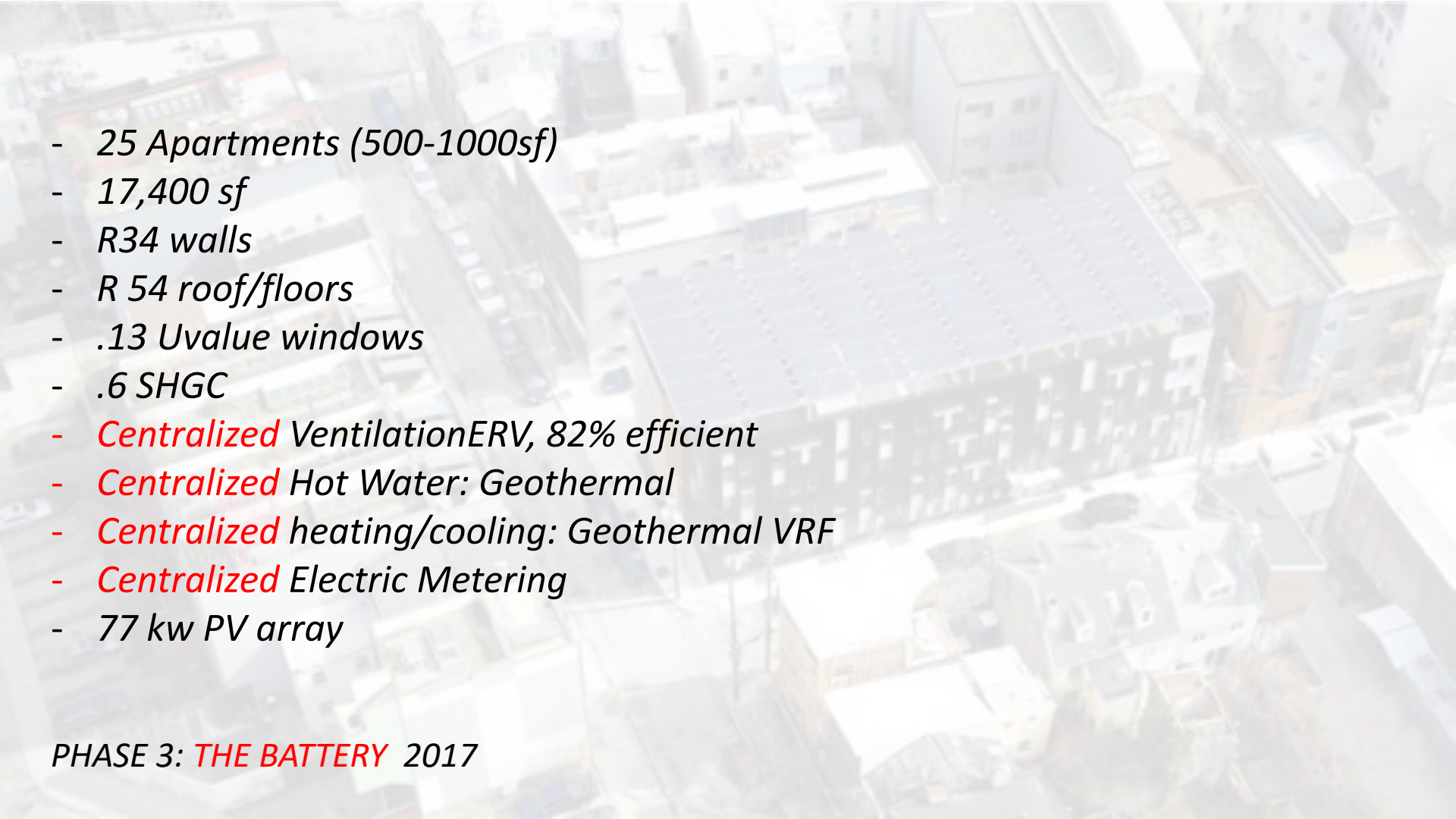
- 
- 25 Apartments (500-1000sf)
 - 17,400 sf
 - R34 walls
 - R 54 roof/floors
 - .13 Uvalue windows
 - .6 SHGC
 - **Centralized** VentilationERV, 82% efficient
 - **Centralized** Hot Water: Geothermal
 - **Centralized** heating/cooling: Geothermal VRF
 - **Centralized** Electric Metering
 - 77 kw PV array

PHASE 3: **THE BATTERY** 2017

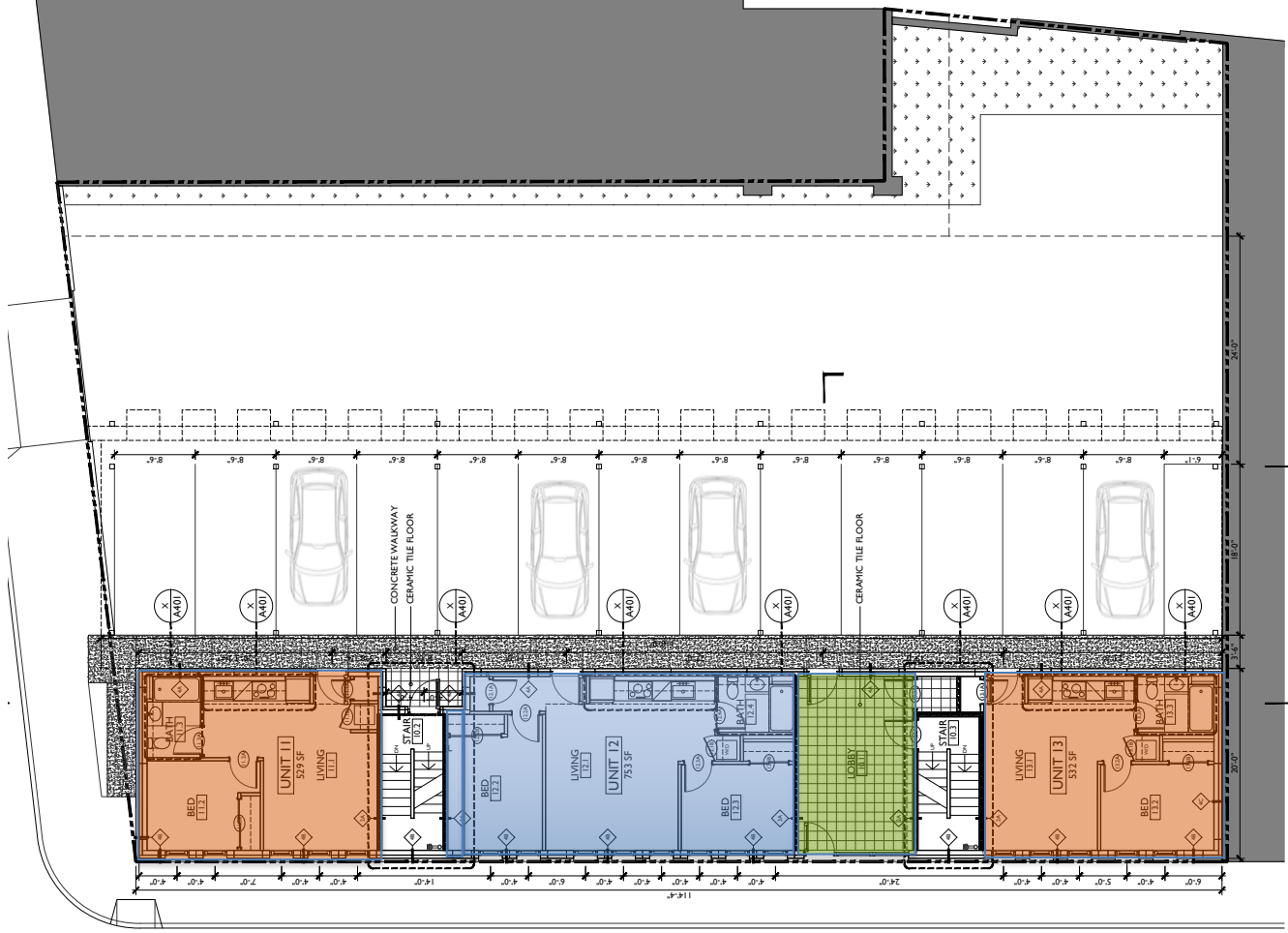

NO PARKING
PARKING

30' WIDE - LEGALLY OPEN
7 - 16 - 7



1st Floor

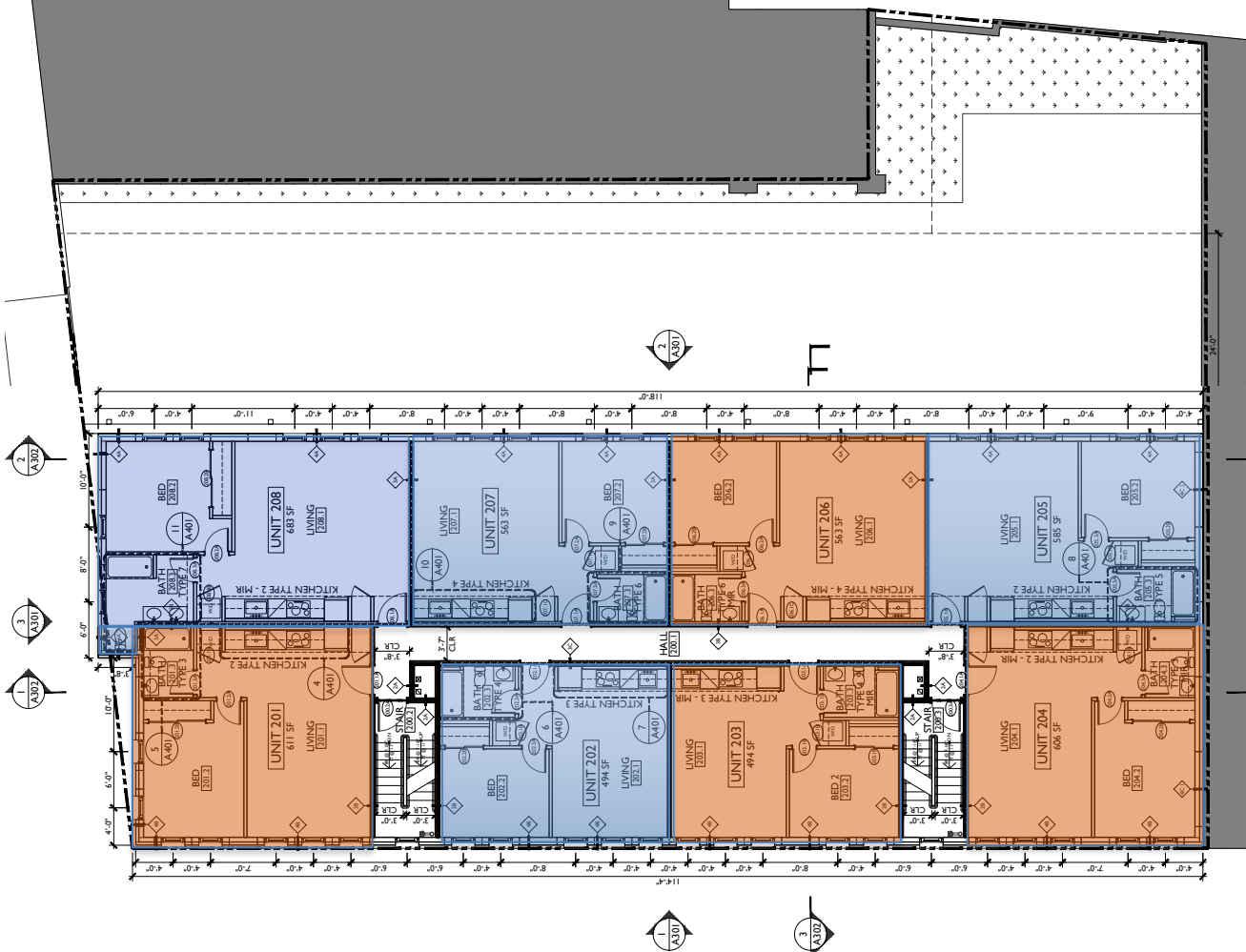

2nd, 3rd, 4th Floors

PANELIZE





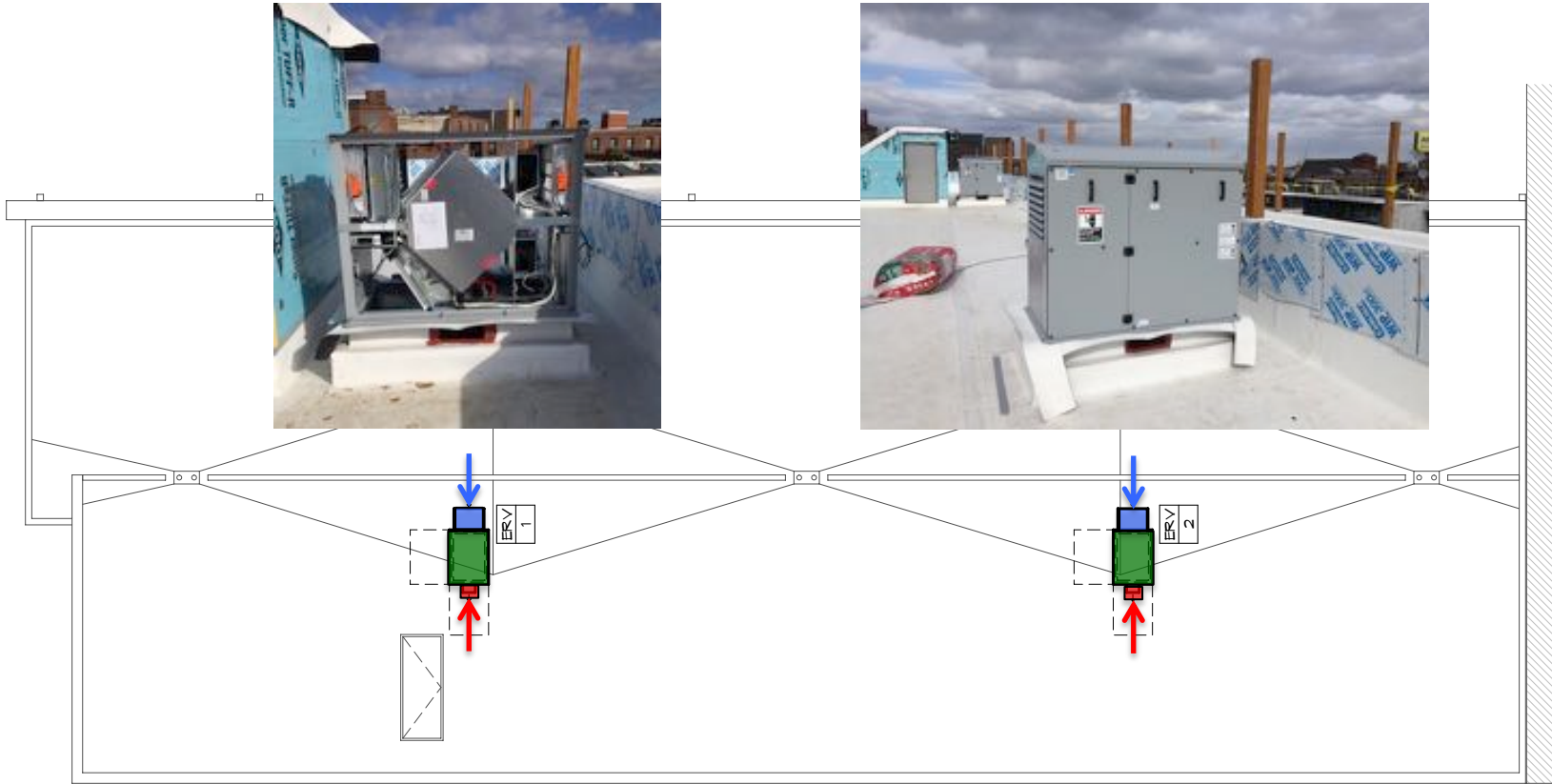

Balanced/Centralized Ventilation, 2 Ventacity 2000cfm ERVs

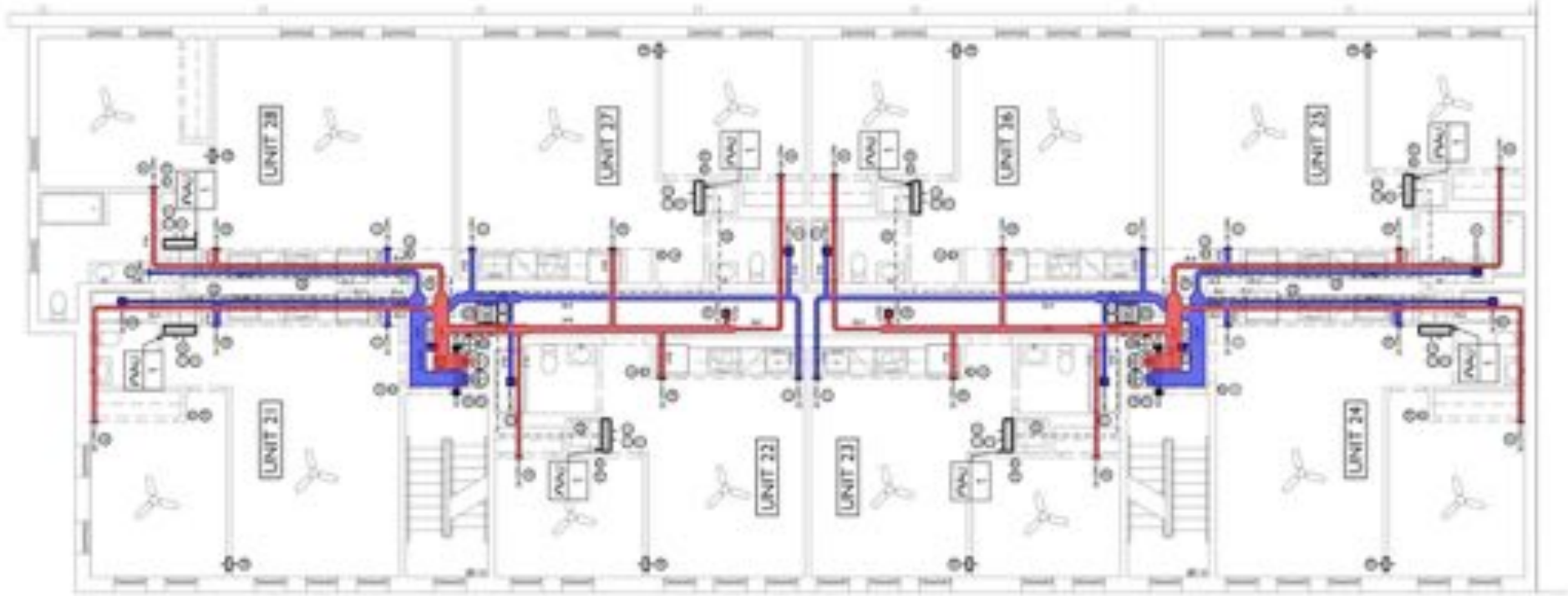

2nd-4th Floors

Balanced/Centralized Ventilation, 2 Ventacity 2000cfm ERVs

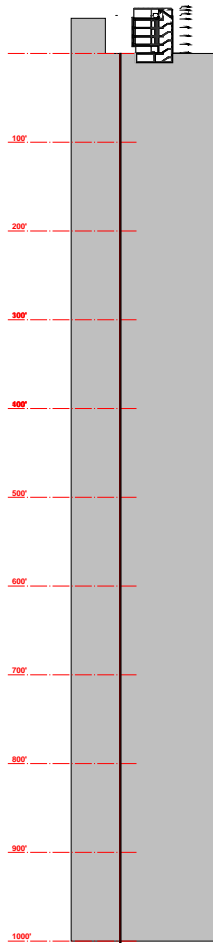

GEOTHERMAL SECTION

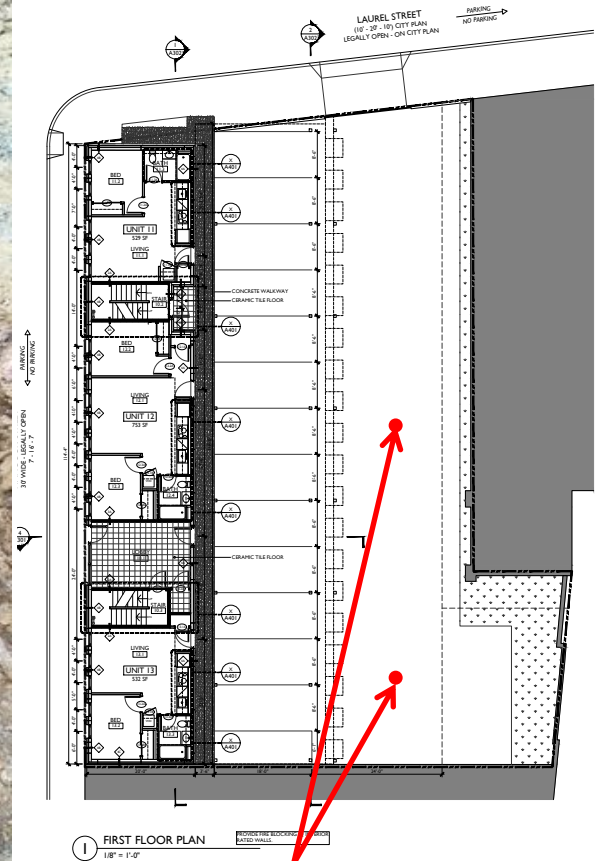

1 FIRST FLOOR PLAN

*2 – 1000' deep Standing Column
Geothermal Wells
ALL heating/cooling and domestic hot water for
ALL 25 apartments*

OPEN TRANSOM TO BEDROOM

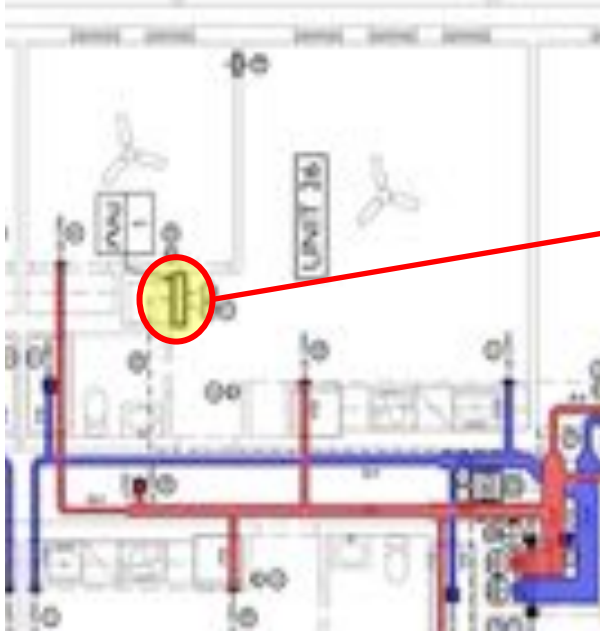

Ductless Evaporator located next to open transom and intentionally located above laundry for easy connection of condensate drain

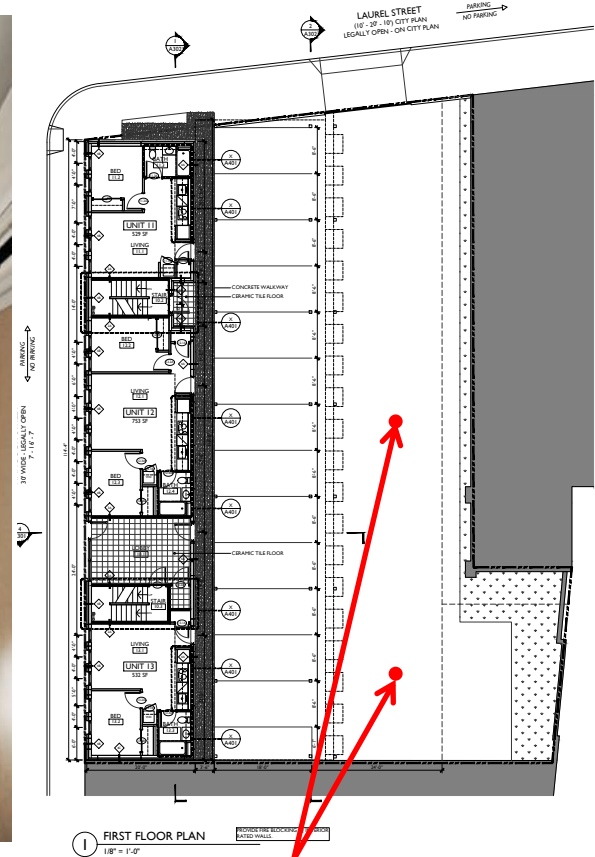

① FIRST FLOOR PLAN
1/8" = 1'-0"

**2 - 1000' deep Standing Column Geothermal Wells
ALL heating/cooling and domestic hot water for ALL 25 apartments**

ELECTRIFY + SIMPLIFY

(master meter)

TENANTS CHARGED
FLAT UTILITY FEE OF
\$50/month

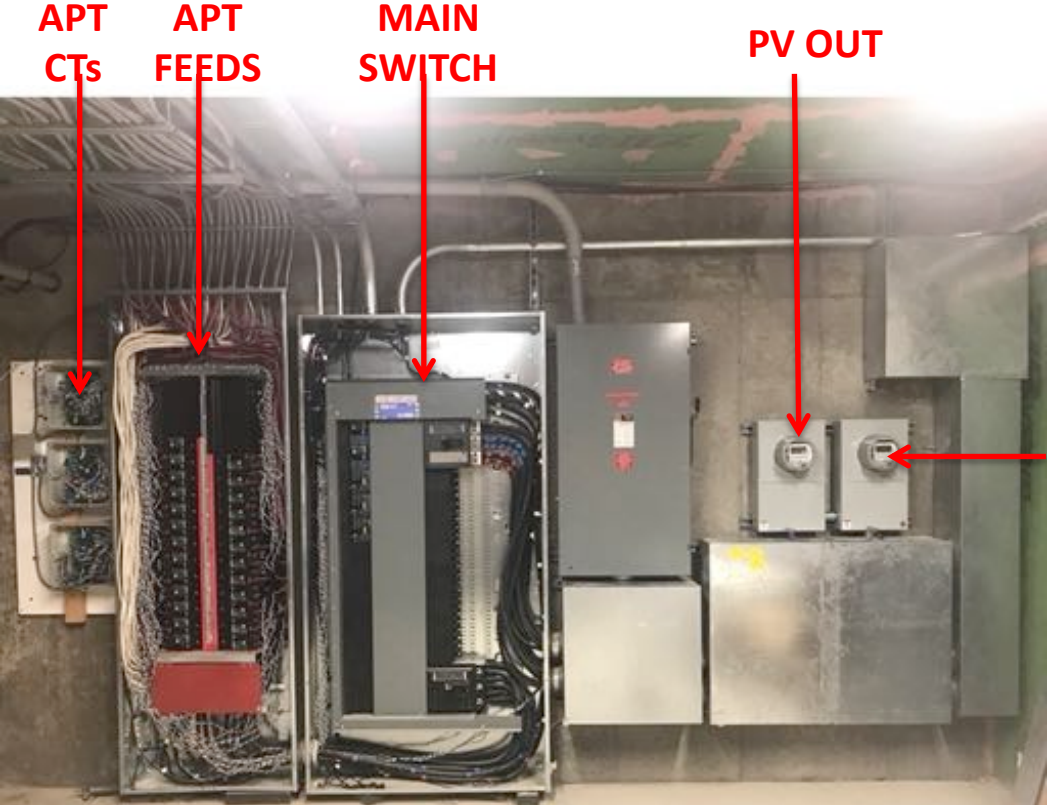

ELECTRICITY
IN



FINAL BLOWER DOOR TEST
Sept 29, 2017
.53 ACH50





INCENTIVIZE
+ EDUCATE



WHO'S WHO???



The Passive House Institute US Awards

The Designation of

PHIUS+ 2015 CERTIFIED PROJECT

No. 1414

Capital Flats II

152-158 W. Laurel Street
Philadelphia, PA 19123

Orion Flats

PROJECT OWNER

April 10, 2018

DATE

Tim McDonald | Kara Haggerty Wilson

CPHC®

Orion Flats Architecture

ARCHITECT

Orion Flats Construction

CONSTRUCTION

Neil Goldman

ON-SITE VERIFICATION

• INTERIOR CONDITIONED FLOOR AREA	16,782	ft ²
• ANNUAL HEATING DEMAND	3.0	kBTU/ft ² ·yr
• ANNUAL COOLING DEMAND	6.2	kBTU/ft ² ·yr
• PEAK HEATING LOAD	3.3	BTU/ft ² ·hr
• PEAK COOLING LOAD	2.8	BTU/ft ² ·hr
• AIR-TIGHTNESS TEST RESULTS	0.05	CFM50/ft ²
• SOURCE ENERGY	4,768	kWh/person·yr
• SITE ENERGY USE INDEX (EUI)	17.0	kBTU/ft ² ·yr

Executive Director



Passive House Institute US



\$169/sf







INTEGRATE SOLAR



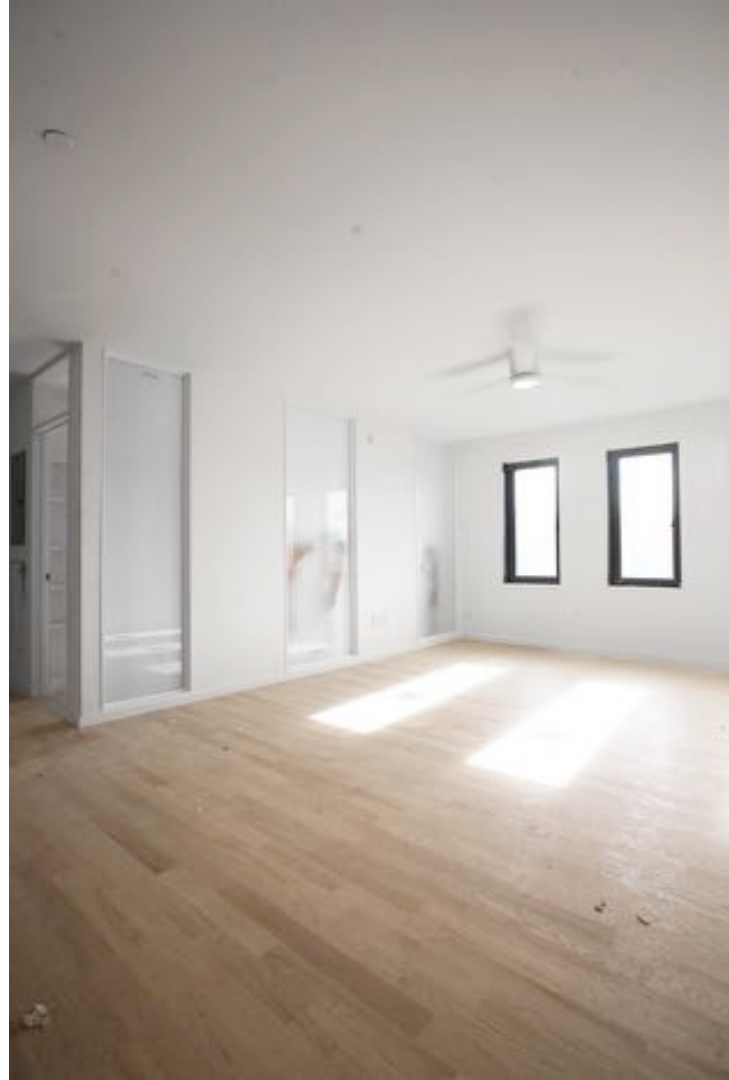

Home

Building Electricity

Apartment Energy

DHW

Data

Summary



DAY

WEEK

MONTH

YEAR





Home Building Electricity Apartment Energy DHW Data

Summary

Battery End Use

2020-2021

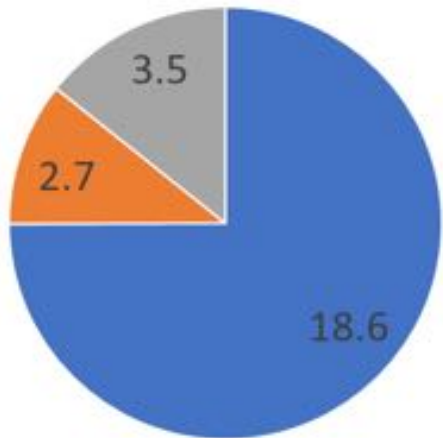

- Total Baseload Site Energy
- Total Heating Site Energy
- Total Cooling Site Energy

EUI: Site Energy Use Intensity Comparison (kBtu/SF)

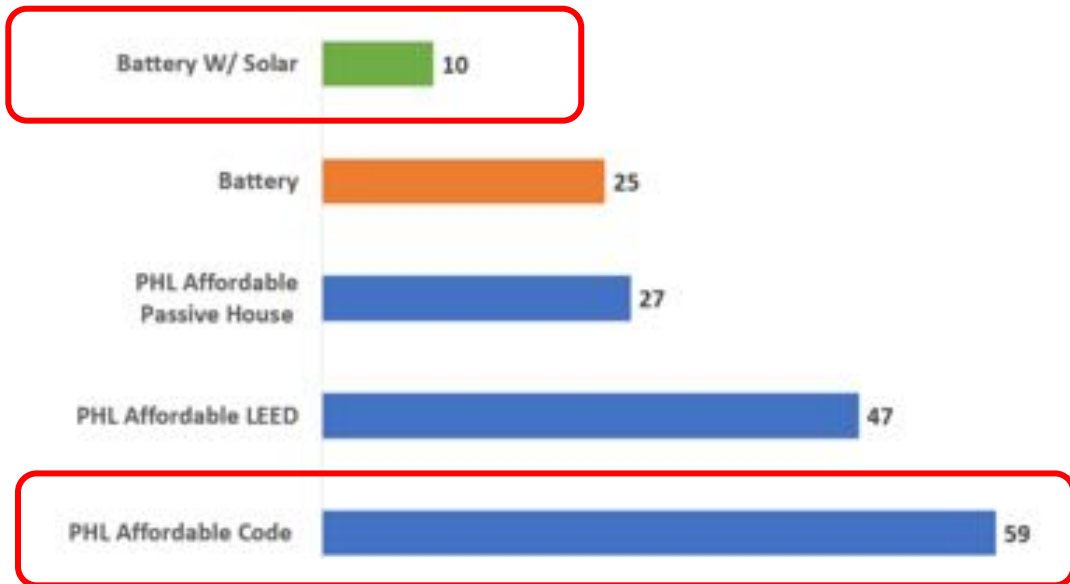

83% BETTER THAN CODE BLDG

FRONT FLATS



FRONT FLATS 2020: 28 units and Office

- 28 Apartments (300-500sf)
- 24,141 sf
- R34 walls, panelized system
- R 54 roof/floors
- **DE-Centralized** VentilationERV
- **DE-Centralized** heating/cooling
- **SEMI-Centralized** Hot Water
- **Centralized** Electric Metering
- 174 kw PV array

FRONT FLATS 2020: 28 units and Office



- 28 Apartments (300-500sf)
- 24,141 sf
- R34 walls, panelized system
- R 54 roof/floors
- *DE-Centralized* VentilationERV
- *DE-Centralized* heating/cooling
- *SEMI-Centralized* Hot Water
- *Centralized* Electric Metering
- 174 kw PV array

FRONT FLATS 2020: 28 units and Office





INTEGRATE SOLAR





FUNCTIONS OF SOLAR VEIL

- Renewable energy generation
- Sun shading device
- Visual privacy device

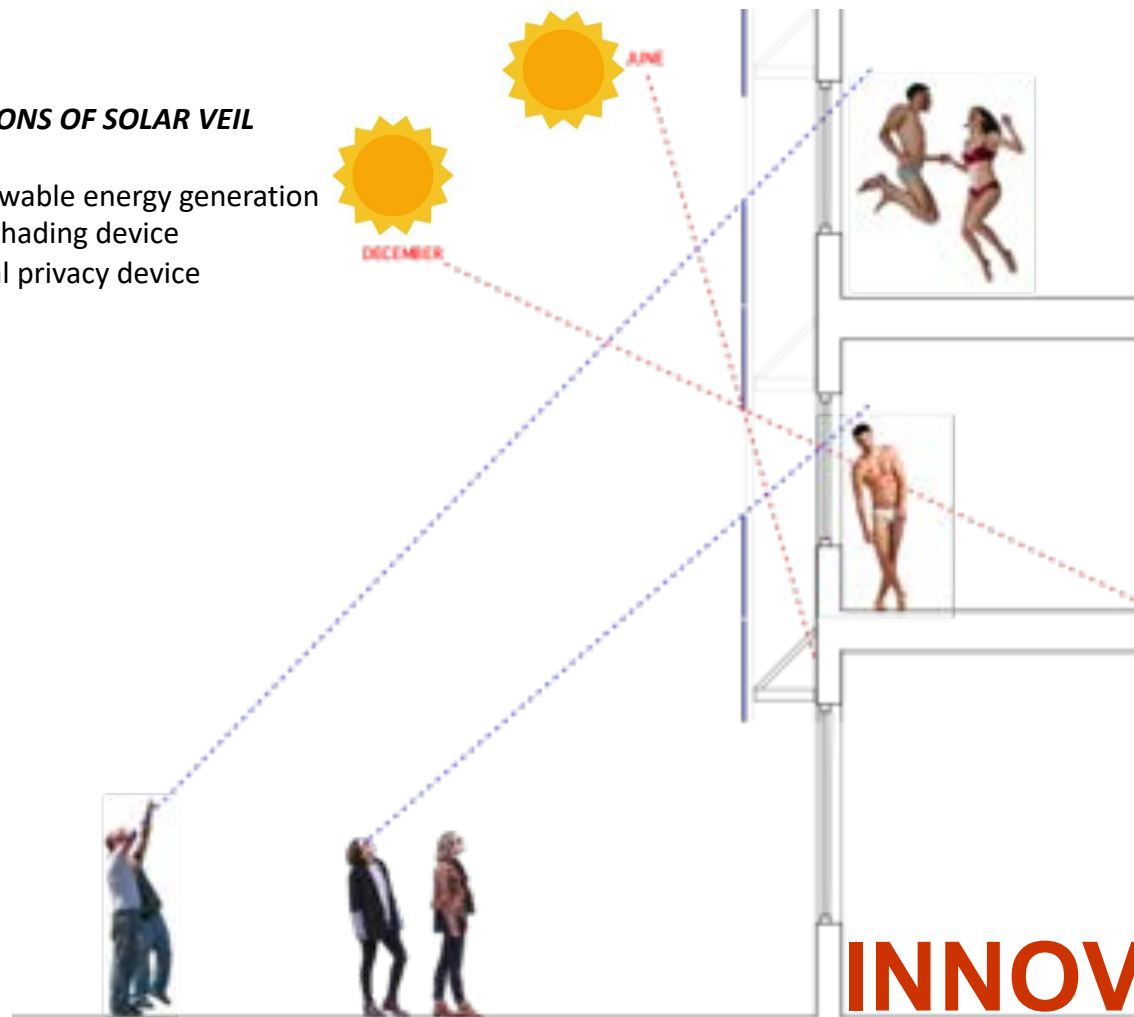

INNOVATE



Project name	Front Flats - Residential Only
Climate	Philadelphia International AP
Type	Residential
Interior conditioned floor area	15,588.9 ft ²
Number of units	28
Occupants	50
Source energy use	723,022.7 kBtu/yr
Specific source energy use	46.4 kBtu/ft ² yr
Source energy use	211,917.9 kWh/yr
Source energy use per person	4,238 kWh/Person yr
Net source energy use (with 100% renewables)	-824,970.6 kBtu/yr
Specific net source energy use (with 100% renewables)	-52.9 kBtu/ft ² yr
Net source energy use (with 100% renewables)	-241,798.9 kWh/yr
Specific source energy use per person (with 100% renewables)	-4,836 kWh/Person yr
PHIUS+ Source Zero	YES

CONSUMPTION
131,648 kWh/yr

PRODUCTION
156,698 kWh/yr

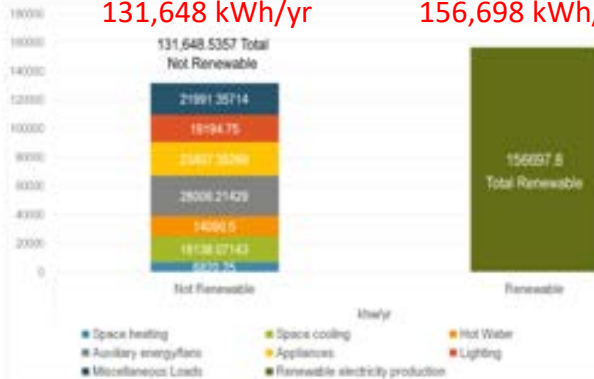

PROJECTED 20% MORE THAN NEEDED



SOLAR
PRODUCTION
165,260kWh/yr

PROJECTED
156,698 kWh/yr

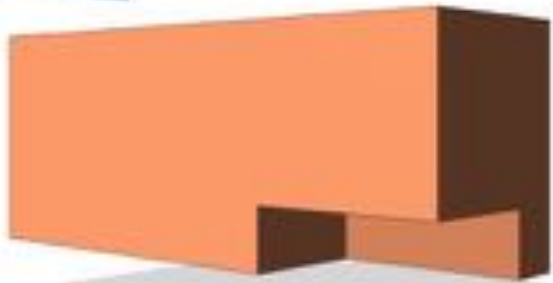

RESIDENTIAL
CONSUMPTION
138,501 kWh/yr

PROJECTED
131,648 kWh/yr

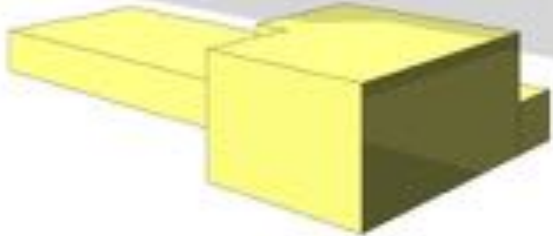

OFFICE/STORAGE
CONSUMPTION
30,402 kWh/yr

TOTAL BUILDING
CONSUMPTION
168,904 kWh/yr

NET *POSITIVE*
RESIDENTIAL
ENERGY PRODUCTION
26, 758 kWh/yr

PROJECTED
25,050 kWh/yr

MONITORED ACTUAL 2020 CONSUMPTION/PRODUCTION

2020 Month	Solar Generation kWh	Total Building Usage kWh
Jan	12,207	9,819
Feb	11,346	9,106
Mar	15,290	9,412
Apr	14,797	9,124
May	15,290	10,065
Jun	18,708	17,237
Jul	16,156	21,471
Aug	13,866	21,706
Sep	15,411	17,411
Oct	12,262	15,399
Nov	11,749	14,593
Dec	8,177	13,562
Total	165,260	168,904



SOLAR
PRODUCTION
165,260kWh/yr

PROJECTED
156,698 kWh/yr



RESIDENTIAL
CONSUMPTION
138,501 kWh/yr

PROJECTED
131,648 kWh/yr

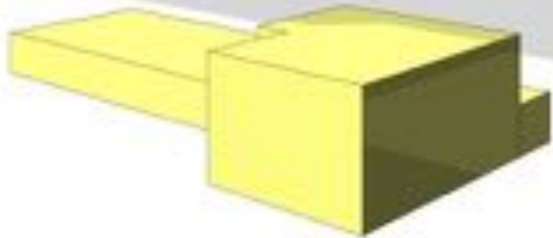

OFFICE/STORAGE
CONSUMPTION
30,402 kWh/yr

TOTAL BUILDING
CONSUMPTION
168,904 kWh/yr

NET *POSITIVE*
RESIDENTIAL
ENERGY PRODUCTION
26, 758 kWh/yr

PROJECTED
25,050 kWh/yr

UTILITIES AS REVENUE

\$40/month x 28 x 12 =

\$13,440.00

26,758 kWh x \$.12=

\$3211.00

\$16,651.00

ADDITIONAL REVENUE



PANELIZATION

***NOTE:**

*Tenants are charged
a flat fee of \$40/month
for all utilities*



ONE METER: Metering vs Monitoring



HEATING, COOLING, VENTILATION, DEHUMIDIFICATION

MINOTAIR

- Decentralized
- Combination ERV, heating, cooling
- Condenser self-contained
- No separate HVAC needed for hallways

INNOVATE

+

VENTILATE

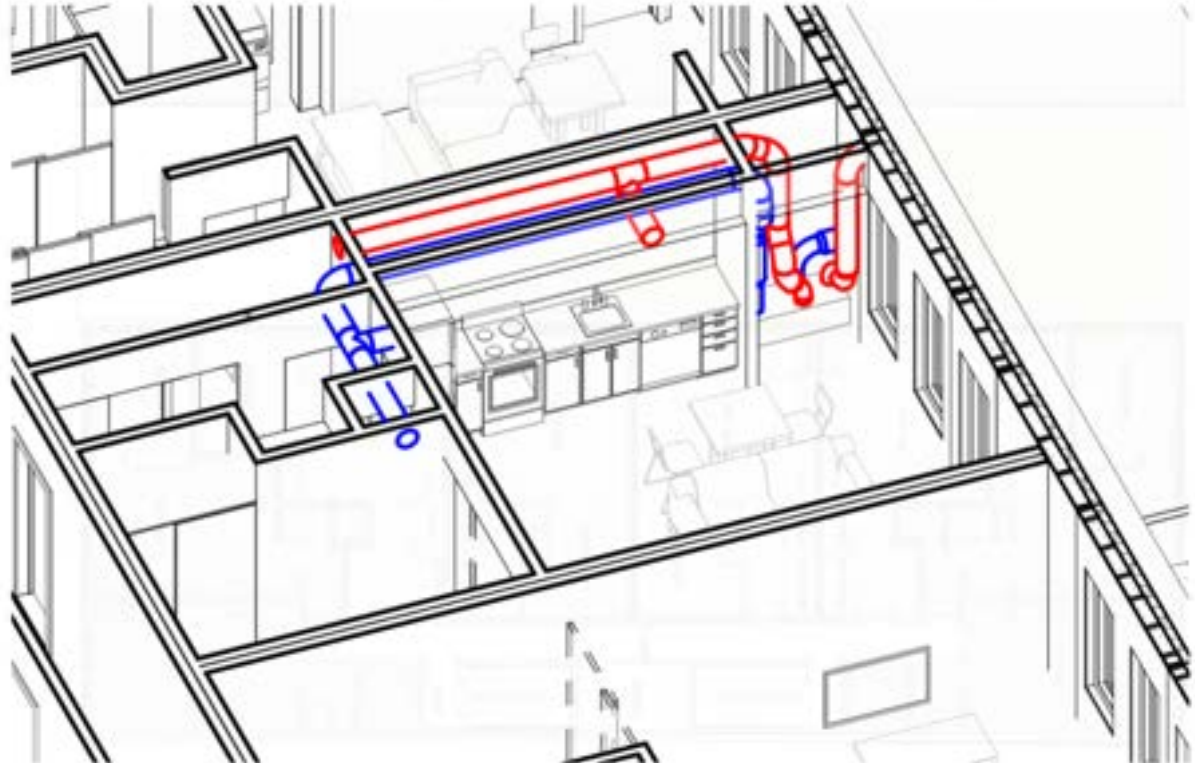

HVAC strategy



HVAC Closet merged with Kitchen cabinetry





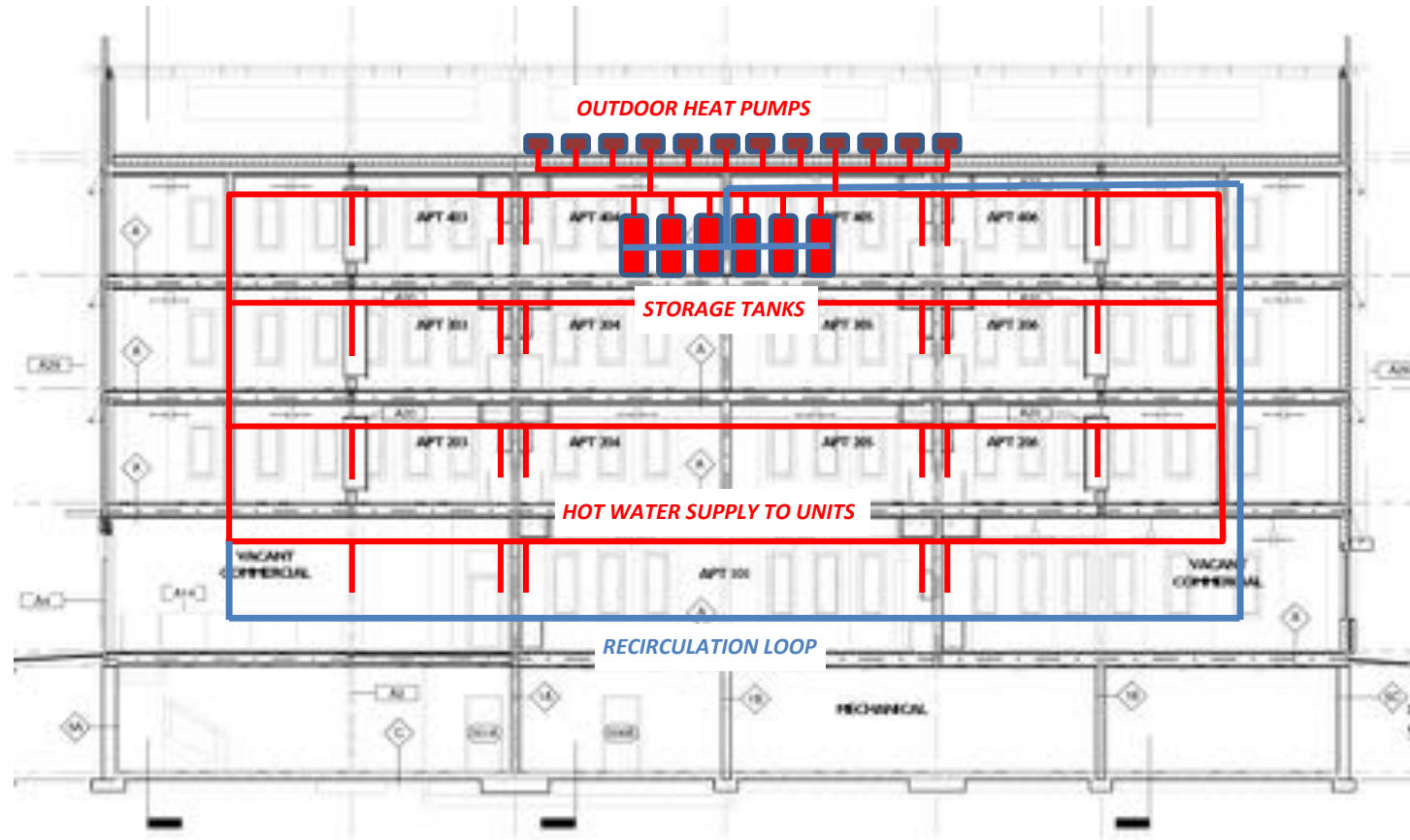

INITIAL Domestic Hot Water Strategy: *CENTRALIZED*

Trap Arm (in.)	(IRC) Distance Trap to Vent	(UPC) Distance Trap to Vent
1 1/4	5ft.	2ft. 6in.
1 1/2	6ft.	3ft. 6in.
2	8ft.	5ft.
3	12ft.	6ft.
4 or larger	16ft.	10ft.

Trap arm length from WC (unfitted) [6ft.]

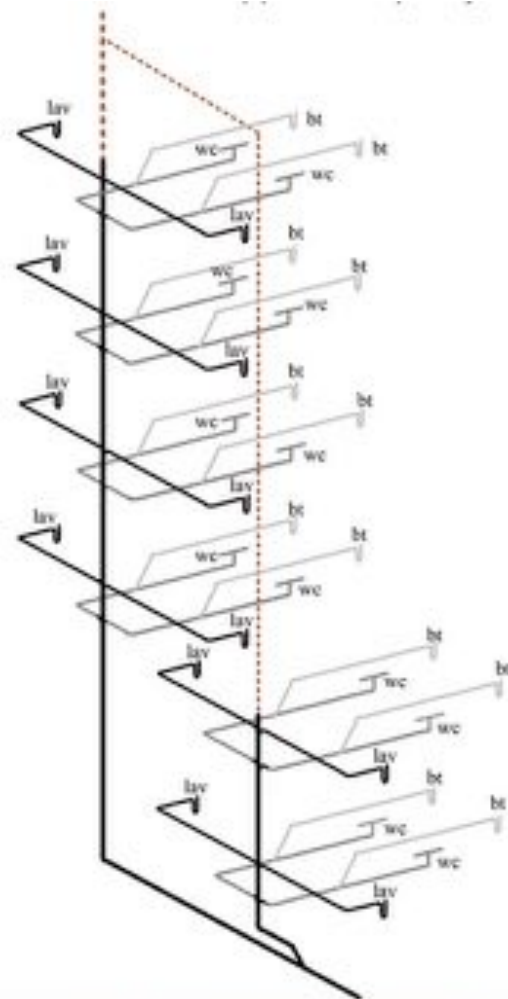
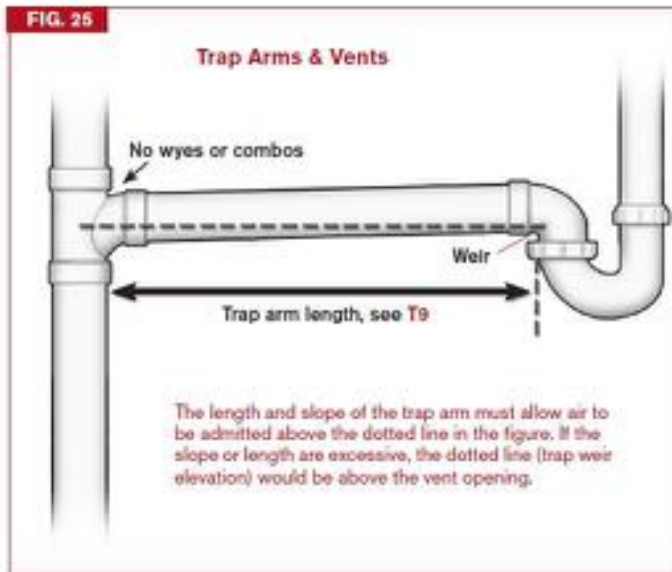

FINAL Domestic Hot Water Strategy: FOLLOW THE VENT STACK!!

Single Stack System for a Six Story Building

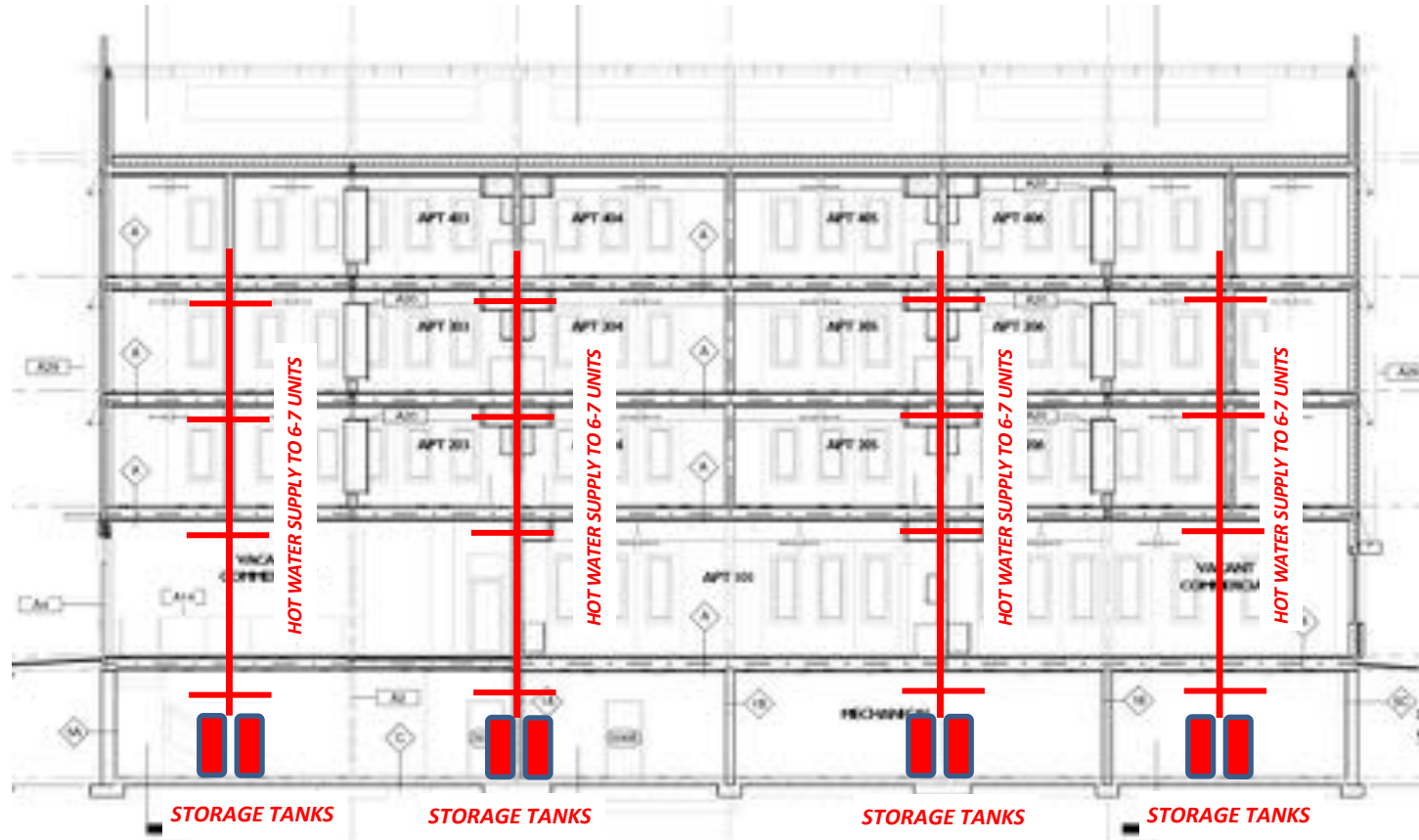

FINAL Domestic Hot Water Strategy: FOLLOW THE VENT STACK!!



RHEEM HPWH

- ½ PRICE!!
- ½" the piping/heat loss
- Located in basement
- Free cooling/dehumidification basement
- No heat pumps on roof
- Proven technology

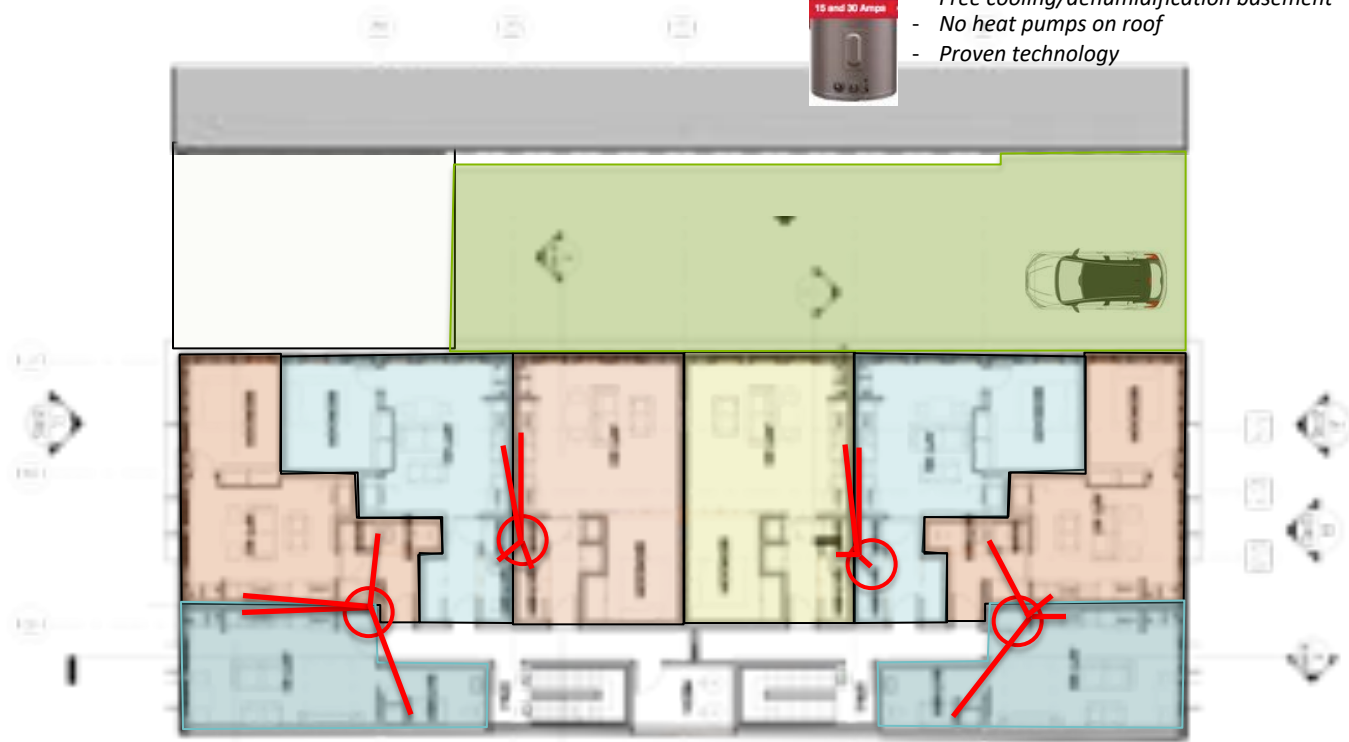

2ND -4TH FLOORS

FINAL Domestic Hot Water Strategy: SEMI-CENTRALIZED

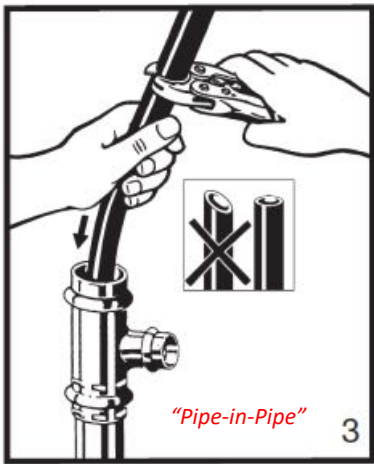

"Pipe-in-Pipe"

3

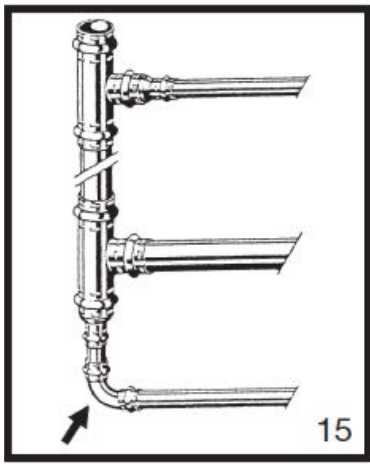

15



RHEEM HPWH

- ½ PRICE!!
- ½" the piping/heat loss
- Located in basement
- Free cooling/dehumidification basement
- No heat pumps on roof
- Proven technology



2ND -4TH FLOORS

PIPE-IN-PIPE Recirculation Loop Strategy

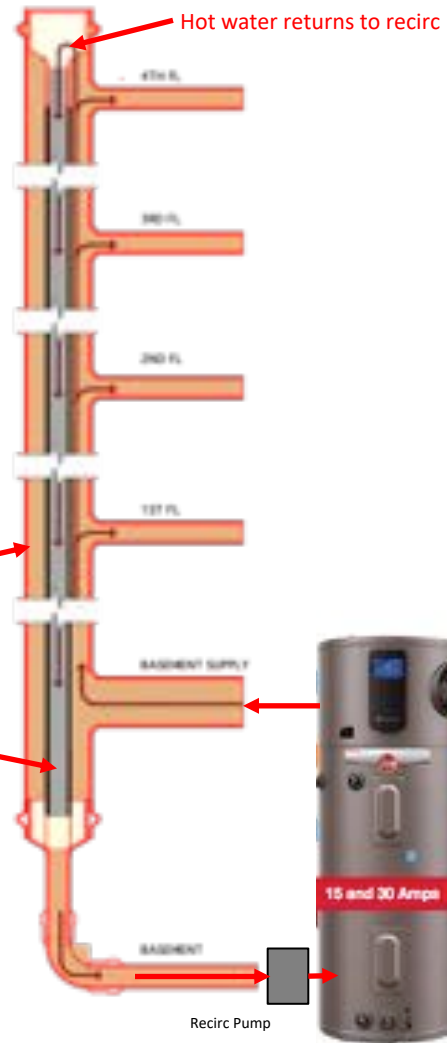
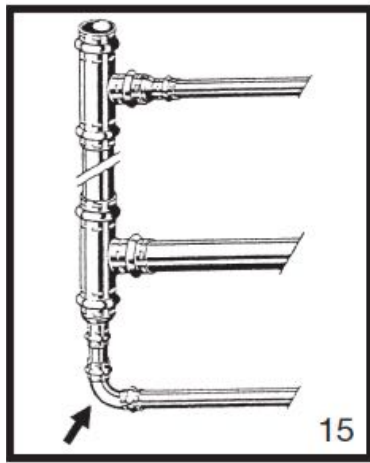
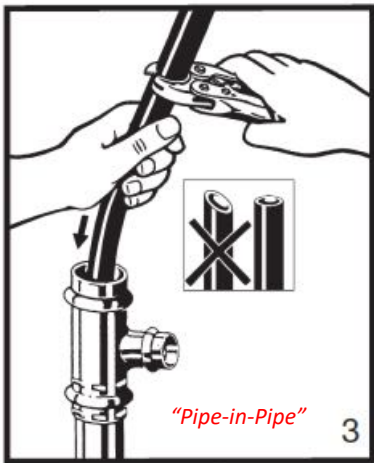

PIPE-IN-PIPE Recirculation Loop Strategy

2 – 80 gallon HPWH for 6-7 Apartments



BELFIELD HOMES
PHILADELPHIA, PENNSYLVANIA 19141



NON-PROFIT
COMMUNITY
ORGANIZATION



PHILADELPHIA
REDEVELOPMENT
AUTHORITY



BELFIELD TOWNHOMES, 2006: 3 subsidized housing units



UNIT ROOF LVL



UNIT PLAN LVL 3



UNIT PLAN LVL 2



UNIT PLAN LVL 1



FIRST

**CERTIFIED
PASSIVE HOUSE
IN
PENNSYLVANIA**

START: APRIL 20, 2012

CERTIFICATE OF OCCUPANCY: JULY 20, 2012



**RECIPIENT OF THE
2014 INTERNATIONAL
PASSIVE HOUSE AWARD**



**SECOND PLACE WINNER
2015 PHIUS AWARD
"AFFORDABLE HOUSING"**





FACTORY BUILD

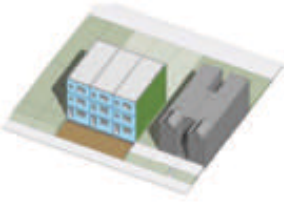
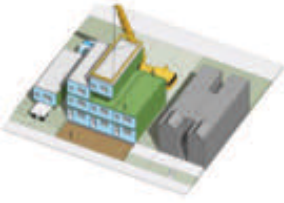
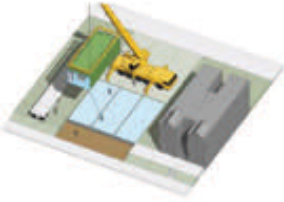
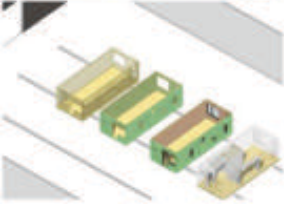

SITE ASSEMBLE

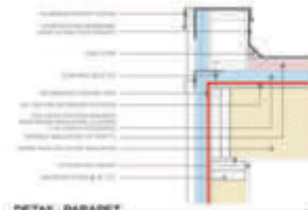

DETAIL: PARAPET



DETAIL: MODULE CONNECTION

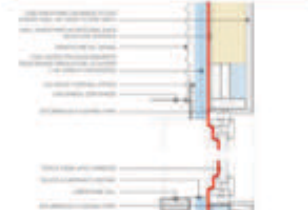

DETAIL: WINDOW



DETAIL: FOUNDATION



Klearwall
TRIPLE-PANE UPVC WINDOWS

PREFABRICATE

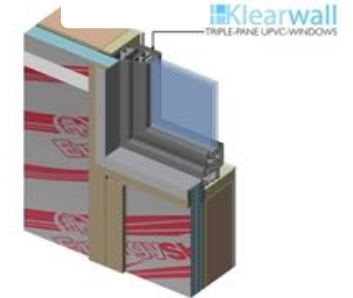

Klearwall
TRIPLE-PANE UPVC WINDOWS

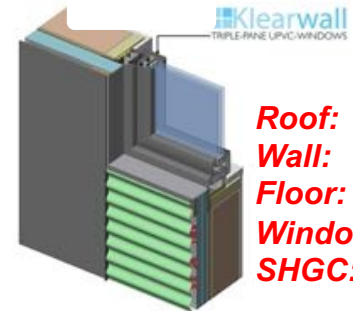

Klearwall
TRIPLE-PANE UPVC WINDOWS

Roof: R52.3
Wall: R33.6
Floor: 58.4
Window: .11
SHGC: .63

BUILDING LEAKAGE TEST COMPARISON

Test #1	Test #2
Test File: Depressurization File	Test File: Pressurization File
Date of Test: 7/5/2012	Date of Test: 7/5/2012
Customer: Orion Flats, LLC 111 West Norris Street Philadelphia, Pennsylvania 19122	Customer: Orion Flats
Phone: 215-783-5591	

Test Results

	Test #1	Test #2	Change	Percent
1. Airflow at 50 Pascals:	293 CFM 0.48 ACH	201 CFM 0.33 ACH	-92 CFM -0.15 ACH	-31.4 % -31.4 %

FINAL AIRFLOW:

0.405 ACH 50

PASSIVE HOUSE MAX

0.6 ACH 50













CONSTRUCTION COSTS

	PER UNIT	PROJECT TOTAL
GENERAL CONDITIONS	\$1,500	\$4,500
EXCAVATION & GRADING	\$3,000	\$9,000
FOUNDATIONS	\$7,000	\$21,000
HELICAL PIERS	\$6,500	\$19,500
SITE UTILITIES (WATER / SEWER / ELECTRIC)	\$10,000	\$30,000
SOLAR PV (5 KW PER HOUSE - 15KW TOTAL)	\$15,000	\$45,000
TOTAL SITE WORK	\$43,000	\$129,000
FRAMING / INSULATION / SHEETROCK / PAINT	\$50,250	\$150,750
EXT.WINDOWS & DOORS	\$9,850	\$29,550
MECHANICAL SYSTEM	\$8,500	\$25,500
PLUMBING & SPRINKLERS	\$9,500	\$28,500
ELECTRICAL	\$5,500	\$16,500
CABINETS / COUNTERTOPS	\$5,500	\$16,500
APPLIANCES	\$6,200	\$18,600
HARDWARE & FINISHES	\$9,300	\$27,900
EXTERIOR CLADDING	\$4,500	\$13,500
E-MONITORING	\$1,900	\$5,700
LABOR / INSPECTIONS / OH-P / DELIVERY / INSTALL	\$95,000	\$285,000
TOTAL MODULAR	\$206,000	\$618,000.00
TOTAL HARD COSTS	\$249,000	\$747,000.00
COST PER SQFT (1920 SQFT x 3 HOMES = 5760 SQFT)		\$129.69

An aerial photograph of a city, likely Washington D.C., showing a large array of solar panels installed on the roof of a prominent building. The surrounding area includes other buildings, trees, and a clear sky with some clouds. The text is overlaid on the center of the image.

Why isn't ALL
AFFORDABLE HOUSING
Built to the PH standard?



PHFA

PENNSYLVANIA HOUSING FINANCE AGENCY



An aerial photograph of a residential development. In the foreground, a modern, multi-story building with a flat roof is covered in solar panels. The building has several windows with teal-colored frames. The surrounding area consists of numerous other residential buildings, some with flat roofs and others with gabled roofs. The background shows a line of trees and a clear blue sky with scattered white clouds. The overall scene is bright and sunny.

**MAKE ALL AFFORDABLE HOUSING
NET-ZERO-ENERGY-CAPABLE BY 2030**

An aerial photograph of a modern, multi-story building with a flat roof covered in solar panels. The building is situated in a residential neighborhood with various other houses and buildings. The sky is blue with scattered white clouds. The text "USE PASSIVE HOUSE AS THE TOOL" is overlaid in the center of the image.

USE PASSIVE HOUSE AS THE TOOL

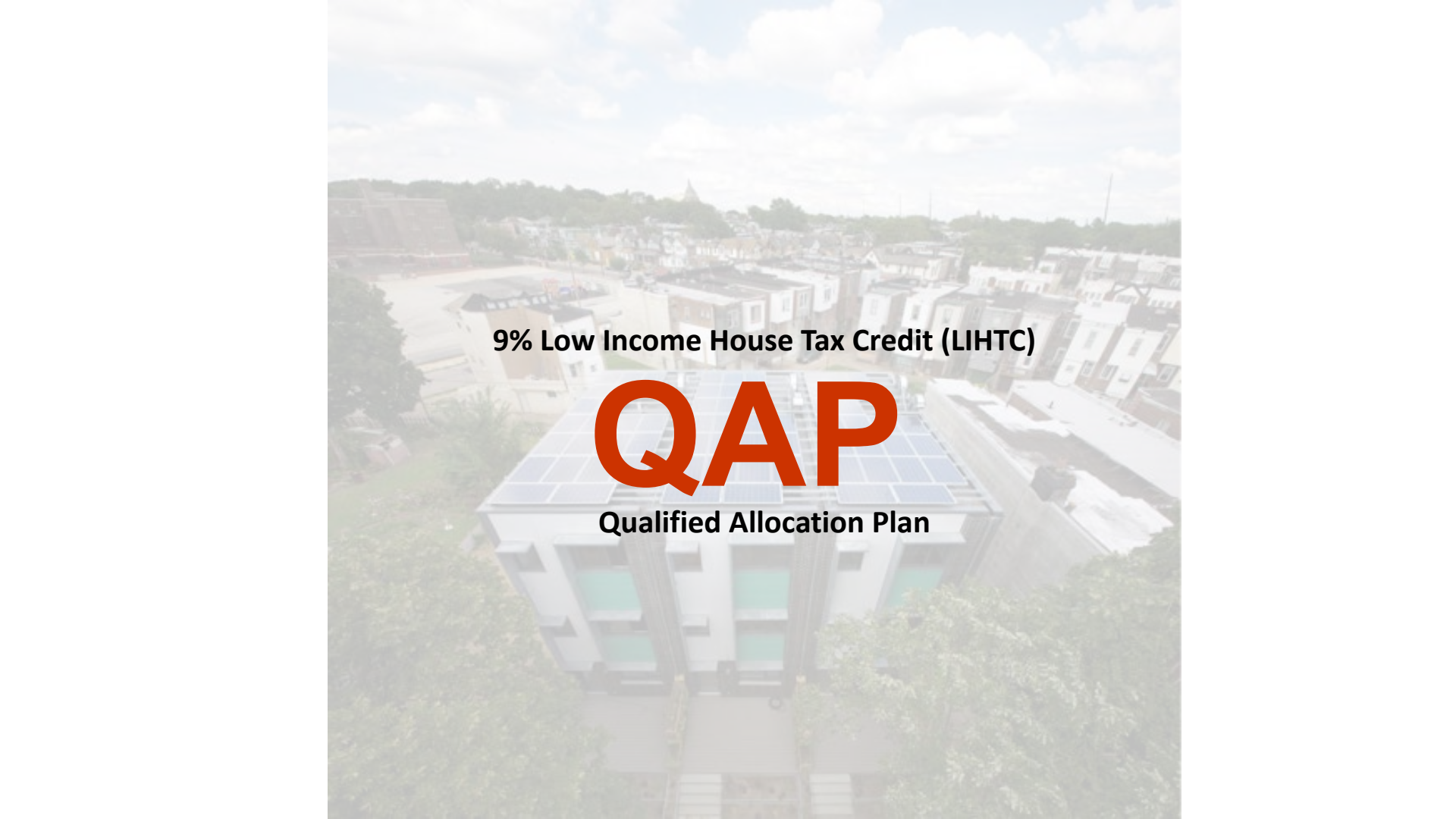
An aerial photograph of a city, likely Baltimore, Maryland, showing a mix of residential and commercial buildings. In the foreground, a modern, multi-story building with a flat roof is covered in solar panels. The building has a grey facade and several windows. The surrounding area includes older brick buildings, a parking lot, and greenery. The sky is blue with scattered white clouds.

9% Low Income House Tax Credit (LIHTC)

QAP

Qualified Allocation Plan

POINTS-BASED SYSTEM



Total points	120
Community and Economic Impact	30
- Underserved Areas	
- Senior Occupancy Developments	
- Preservation	
Development Characteristics	25
- Smart Site Selection	
- Enterprise Green Communities	
Resident Population and Services	50
- Income and Rent Targeting	
- Designated Populations and Supportive Services	
- Accessible Units	
- Large Families	
Development Process	15
- Noncompliance	
- Ability to Proceed	
Development Cost Savings	10

POINTS-BASED SYSTEM

Total points	120
Community and Economic Impact	30
- Underserved Areas	
- Senior Occupancy Developments	
- Preservation	
Development Characteristics	25
- Smart Site Selection	
- Enterprise Green Communities	
- PASSIVE HOUSE	10
Resident Population and Services	50
- Income and Rent Targeting	
- Designated Populations and Supportive Services	
- Accessible Units	
- Large Families	
Development Process	15
- Noncompliance	
- Ability to Proceed	
Development Cost Savings	10

38% applied as Passive House projects

7 PH projects Funded

YEAR 1 A NATIONAL Net-Zero-Energy Initiative by **2030**
2015

Construction Cost Summary from PHFA Applications

2015 Costs

Single Family / Townhouse

Proj. No.	County	Climate Zone	Units (by BR Qty)					Total Units	Bldg. Area	Constr. \$	\$/Unit	\$/SF	
			0	1	2	3	4+						
SF-1	Franklin	5A			33	21		54	70,218	7,051,522	130,584	100	
SF-2	Schuykill	5A		3	9		5	17	21,151	2,238,725	131,690	106	
SF-3	Philadelphia	4A		5	19	31		5	60	79,795	9,363,626	156,600	117
SF-4	Allegheny	5A			26	19		45	63,548	8,863,631	196,970	117	
SF-5	Lycoming	5A			16	34		50	66,147	8,141,437	162,829	123	
SF-6	Bradford	5A		10	24	16		50	62,956	7,964,823	159,296	127	
SF-7	Centre	5A			20	20		40	53,652	7,523,233	188,081	140	
SF-8	Lebanon	5A			46	16		62	84,168	11,742,459	189,395	140	
SF-9	Bradford	5A		2	26	12		40	59,954	8,369,296	209,232	140	
SF-10	Butler	5A		3	39	18		60	67,904	9,827,275	163,788	145	
SF-11	Erie	5A			9	34		43	53,454	7,870,669	183,039	147	
SF-12	Dauphin	5A		3	3	25	4	35	61,504	9,192,750	262,650	149	
SF-13	Berks	5A		22	20	16		58	62,097	9,305,340	160,437	150	
SF-14	Franklin	5A		7	25	24		56	77,469	11,791,991	210,571	152	
SF-15	Luzerne	5A		26	15	15		56	56,250	8,968,491	160,152	159	
SF-16	Union	5A		5	12	8	6	31	43,868	7,071,066	228,099	161	
SF-17	Chester	4A		48	12			60	58,349	9,809,238	163,487	168	
SF-18	Allegheny	5A		4	30	18		52	77,351	12,979,386	249,604	168	
SF-19	Berks	5A		10	21	11		42	57,722	9,785,000	232,976	170	
SF-20	Montgomery	4A		16	24	15		55	61,480	11,113,700	202,067	181	
SF-21	Delaware	4A		8	34	14		56	65,790	12,184,074	217,573	185	
SF-22	Philadelphia	4A			17	16	2	35	45,476	8,905,240	254,435	196	
SF-23	Allegheny	5A		14	9			23	28,205	5,552,583	241,417	197	
SF-24	Westmoreland	5A		28	8			36	43,872	8,331,567	231,432	245	
SF-25	Philadelphia	4A		10	19	11		40	46,757	11,453,809	286,345	245	

Adaptive Reuse

AR-1	Lehigh	5A		34	4	11		49	65,339	6,392,809	130,465	98
AR-2	Erie	5A		29	16			45	53,021	6,152,972	136,733	116
AR-3	Philadelphia	4A	12	54				66	77,975	9,751,707	147,753	125
AR-4	Allegheny	5A	2	49	4			55	65,577	9,514,764	172,996	145
AR-5	Delaware	4A		53				53	51,690	8,030,480	151,518	155
AR-6	Philadelphia	4A		44				44	49,406	8,361,579	190,036	169
AR-7	Montgomery	4A		33	3	7		43	55,832	9,468,816	220,205	170
AR-8	Philadelphia	4A			28	10		38	53,840	9,515,893	250,418	177
AR-9	Dauphin	5A	5	17	6			28	45,434	8,075,064	288,395	178
AR-10	Allegheny	5A		33	3			36	50,664	9,436,523	262,126	186
AR-11	Philadelphia	4A		46				46	56,478	10,795,027	234,675	191
AR-12	Philadelphia	4A		27	10			37	48,768	9,658,098	261,030	198
AR-13	Philadelphia	4A		30	21			51	62,509	13,609,683	266,857	218
AR-14	Washington	4A		17	7			24	35,299	7,856,113	327,336	223
AR-15	Philadelphia	4A		62				62	70,991	25,995,741	419,286	366

Multi-Story / Elevator

MS-1	Northumberland	5A		35																106
MS-2	Dauphin	5A		22	14			50	88,314	10,055,562	201,111	114								
MS-3	Dauphin	5A		18	59			77	92,000	10,668,511	138,552	116								
MS-4	Lancaster	5A		46	6			52	71,758	8,456,719	162,629	118								
MS-5	Blair	5A		33	20			53	82,070	9,727,007	183,528	119								
MS-6	Chester	4A		46	15			61	76,340	9,638,964	158,016	126								
MS-7	Lancaster	5A		13	39	26		78	88,910	11,681,226	149,759	131								
MS-8	Clearfield	6A		24	6			30	42,254	5,551,584	185,053	131								
MS-9	Indiana	5A		40				40	36,743	4,898,995	122,475	133								
MS-10	Bradford	5A		50	6			56	57,817	7,738,172	138,182	134								
MS-11	Cambria	5A		32	11			43	44,887	6,341,616	147,479	141								
MS-12	Dauphin	5A		38	16		54	58,335	8,201,250	151,875	141									
MS-13	Mifflin	5A		30	4			34	39,447	5,559,187	163,506	141								
MS-14	Yayette	5A		12	12			24	29,566	4,192,325	174,680	142								
MS-15	Allegheny	5A		24	12	13		49	67,340	9,698,634	197,931	144								
MS-16	Lackawanna	5A		44	4			48	49,460	7,159,738	149,161	145								
MS-17	Lehigh	5A		54	7			61	63,949	9,318,159	152,757	146								
MS-18	Centre	5A		37	11			48	57,959	8,490,644	176,888	146								
MS-19	Chester	4A		41	3	5	49	54,287	8,007,477	163,418	148									
MS-20	Fayette	5A		21	3		24	36,064	5,407,359	225,307	150									
MS-21	Chester	4A		61	3		64	70,083	10,557,500	164,961	151									
MS-22	Allegheny	5A		54	12		66	70,689	10,787,052	163,440	153									
MS-23	Allegheny	5A		40	6		46	58,617	9,134,790	198,582	156									
MS-24	Wayne	6A		36	4		40	40,959	6,460,530	161,513	158									
MS-25	Centre	5A			12		12	16,796	2,683,900	223,658	160									
MS-26	Beaver	5A		40	12		52	55,361	9,468,440	182,085	171									
MS-27	Lancaster	5A		51			51	51,500	8,871,635	173,954	172									
MS-28	Allegheny	5A		52	8		60	66,733	11,716,729	195,279	176									
MS-29	Montgomery	4A		40	4		44	44,687	8,202,314	186,416	184									
MS-30	Montgomery	4A		50			50	42,265	8,029,015	160,580	190									
MS-31	Crawford	5A		36	4		40	38,953	7,490,675	187,267	192									
MS-32	Philadelphia	4A		9	8	7	24	31,220	6,031,050	251,294	193									
MS-33	Westmoreland	5A		47			47	49,080	9,825,224	209,047	200									
MS-34	Philadelphia	4A		58	4		62	56,120	11,262,762	181,657	201									
MS-35	Philadelphia	4A	60				60	57,672	11,915,227	198,587	207									
MS-36	Philadelphia	4A		20	4		24	26,284	5,523,620	230,151	210									
MS-37	Philadelphia	4A		34	11		45	42,523	8,964,723	199,216	211									
MS-38	Philadelphia	4A		52			52	50,275	10,703,403	205,835	213									
MS-39	Philadelphia	4A		39	11		50	53,416	11,371,112	227,422	213									
MS-40	Philadelphia	4A		45	5		50	55,099	11,747,269	234,945	213									
MS-41	Philadelphia	4A		24			24	24,284	5,194,462	216,436	214									
MS-42	Philadelphia	4A		45			45	46,754	10,118,014	224,845	216									
MS-43	Philadelphia	4A		53			53	50,312	10,900,733	205,674	217									
MS-44	Philadelphia	4A		54			54	48,965	10,664,381	197,489	218									
MS-45	Philadelphia	4A	88				88	79,650	18,005,791	204,611	226									

CONSTRUCTION COST OF PROPOSED PROJECTS TO PHFA 2015

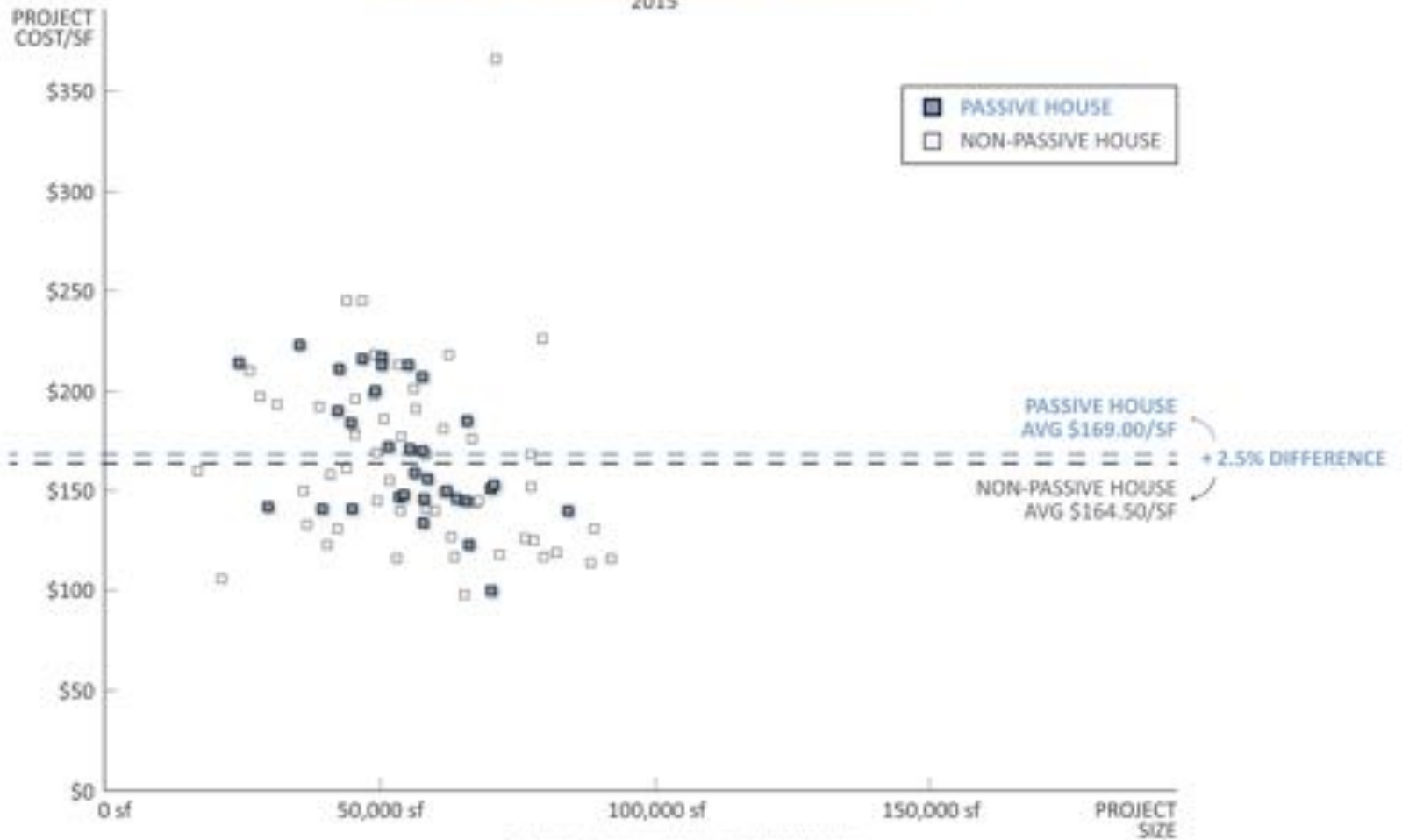

DATA SOURCE: PENNSYLVANIA HOUSING FINANCE AGENCY

© Onion Flats 2016. Prepared by NK Architects



St, John Nueman
Phila, PA
52 Units



Wynne
Phila, PA
51 Units



Sacred Heart
Allentown, PA
61 Units



WhiteHall
Spring City, PA
49 Units



Hillcrest
Pittsburgh, PA
65 Units



Washington Square
Townhomes
Chambersburg, Pa
54 Units



Mann Edge
Lewistown, Pa
34 Units



7 Passive House Projects **COMPLETED**

Construction Cost Change from Application to Construction Completion

Proj. No.	Total Units	Resid't'l Bldg. Area	\$/SF @ Applic	\$/SF @ Cost Cert	% Change
2015-443	51	62,509	\$ 218	\$ 186	-15%
2015-431	52	43,868	\$ 296	\$ 287	-3%
2015-436	23	28,205	\$ 197	\$ 193	-2%
2015-608	40	40,959	\$ 158	\$ 157	-1%
2015-810	35	61,504	\$ 149	\$ 149	-1%
2015-419	28	45,434	\$ 178	\$ 178	0%
2015-809	37	48,768	\$ 198	\$ 199	1%
2015-612	31	43,868	\$ 161	\$ 162	1%
2015-804	88	79,650	\$ 226	\$ 228	1%
2015-416	66	70,689	\$ 153	\$ 155	2%
2015-466	40	53,652	\$ 140	\$ 144	3%
2015-619	34	39,447	\$ 141	\$ 145	3%
2015-806	49	54,287	\$ 148	\$ 151	3%
2015-445	50	55,099	\$ 220	\$ 226	3%
2015-439	53	51,690	\$ 155	\$ 163	5%
2015-448	44	49,406	\$ 169	\$ 177	5%
2015-449	61	63,949	\$ 149	\$ 157	5%
2015-616	24	36,064	\$ 150	\$ 160	7%
2015-620	53	82,070	\$ 119	\$ 129	8%
2015-807	43	55,832	\$ 170	\$ 185	9%
2015-614	45	53,021	\$ 116	\$ 128	10%
2015-440	52	50,275	\$ 213	\$ 233	10%
2015-415	56	56,250	\$ 159	\$ 176	10%
2015-610	54	70,218	\$ 100	\$ 111	11%
2015-467	45	63,548	\$ 139	\$ 154	11%
2015-459	12	16,796	\$ 160	\$ 181	13%

NON-PASSIVE HOUSE

Application
\$171 SF

Completion
\$176 SF
3% Higher

PASSIVE HOUSE

Application
\$161 SF

Completion
\$168 SF
4% Higher

**NOTE 3-5% Contingency added to budgets after application*

10 PH projects Funded

Construction Cost Summary for PHFA 2016 Applications												
Proj. No.	County	Climate Zone	Units by BR Qty					Total Units	Resid. Bldg. Area	Resid. Constr. \$	\$ / Unit	\$ / SF
			0	1	2	3	4+					
SF-01	Dauphin	5A		14	16	15	15	60	99,625	10,419,031	173,654	105
SF-02	Lebanon	5A		9	32	14		55	78,627	8,446,000	153,567	107
SF-03	Lycoming	5A		20	40			60	82,730	9,436,382	157,237	114
SF-04	Columbia	5A			7	17		24	48,499	5,669,777	236,244	117
SF-05	Philadelphia	4A		5	19	31	5	60	79,795	9,739,093	162,313	122
SF-06	Wyoming	5A			30	12		42	72,100	9,168,380	218,250	127
SF-07	Erie	5A		8	20	18		46	85,819	10,964,900	238,368	128
SF-08	Lancaster	5A		6	33	21		60	78,825	10,259,118	170,980	130
SF-09	Cumberland	5A			18	34		52	75,275	9,921,606	190,801	132
SF-10	Centre	5A		6	24	18		48	75,737	10,193,457	212,366	135
SF-11	Lehigh	5A		19	27	16		62	71,254	9,631,860	155,335	135
SF-12	Lancaster	5A		41	79	18		138	154,370	21,137,388	153,108	137
SF-13	Erie	5A			9	31		40	53,454	7,870,669	196,761	147
SF-14	Montgomery	4A			19	29		48	59,976	8,858,000	184,541	148
SF-15	Lebanon	5A			49	13		62	82,974	12,349,192	199,118	149
SF-16	Cumberland	5A			10	30	10	50	72,707	10,865,524	217,311	149
SF-17	Schuylkill	5A		1	11	5		17	21,544	3,225,548	189,733	150
SF-18	Berks	5A			10	21	11	42	57,722	8,755,000	208,432	152
SF-19	Berks	5A			22	20	16	58	62,097	9,440,383	162,760	152
SF-20	Franklin	5A			6	21	21	48	66,583	10,404,256	216,759	156
SF-21	Lehigh	5A		9	15	20	4	48	53,333	8,377,963	174,541	157
SF-22	Chester	4A			19	18	11	48	58,541	9,248,927	192,681	158
SF-23	Cumberland	5A		5	22	8		35	44,186	7,656,200	218,740	173
SF-24	Montgomery	4A		8	21	15	6	50	65,907	11,589,411	231,781	176
SF-25	Allegheny	5A		35	16	14		65	87,255	15,376,648	236,561	176
SF-26	Delaware	4A		8	34	14		56	65,212	11,914,849	212,761	183
SF-27	Philadelphia	4A			17	16	2	35	45,476	9,441,620	269,761	208
SF-28	Armstrong	5A			24			24	28,812	6,017,450	250,723	209
SF-29	Philadelphia	4A			28	14		42	47,964	10,022,268	238,620	209
SF-30	Philadelphia	4A		11	10	11		32	31,619	6,732,433	210,381	213
SF-31	Philadelphia	4A		8	19	24	4	55	66,383	19,011,723	345,681	286
SF-32	Philadelphia	4A		45				45	23,302	7,408,602	164,631	318
AR-01	Monroe	5A		36	4			40	54,215	5,753,672	143,821	106
AR-02	Luzerne	5A		6	54	2		62	88,489	9,900,711	159,639	112
AR-03	Philadelphia	4A		12	54			66	77,978	10,123,117	153,311	130
AR-04	Allegheny	5A		33	8			41	70,409	9,181,888	223,833	130
AR-05	Butler	5A		44	18			62	73,114	10,046,992	162,033	137
AR-06	Washington	5A		24				24	41,046	6,169,663	257,039	150
AR-07	Allegheny	5A		2	49	4		55	65,190	10,592,039	192,533	162
AR-08	Delaware	4A			50			50	50,548	8,727,828	174,577	173
AR-09	Philadelphia	4A			60			60	65,041	11,803,992	196,733	181
AR-10	Philadelphia	4A			74			74	93,285	20,223,060	273,255	217
AR-11	Philadelphia	4A		20	37			57	63,960	14,005,881	245,717	219
AR-12	Perry	5A		28	3			31	36,152	8,548,665	275,733	236

MS-01	Berks	5A		40	20			60	62,149	7,432,636	123,871	120
MS-02	Tioga	6A		34	6			40	48,735	5,999,734	149,933	123
MS-03	Dauphin	5A		35	2			37	43,964	5,421,065	146,515	123
MS-04	Bradford	5A		38	12	6		56	63,768	8,446,000	150,831	132
MS-05	Lancaster	5A		46	6			52	92,370	12,565,629	241,616	136
MS-06	Fayette	5A		12	12			24	28,904	3,942,323	164,236	136
MS-07	Cambria	5A		32	11			43	49,491	6,879,001	159,973	139
MS-08	Clearfield	6A		24	6			30	41,915	5,855,263	195,115	140
MS-09	Chester	4A		56	3			59	64,180	9,033,100	153,183	141
MS-10	Centre	5A		16	34			50	60,912	8,666,068	173,331	142
MS-11	Clinton	5A		28	4			32	37,454	5,333,806	166,616	142
MS-12	Allegheny	5A		24	12	13		49	67,340	9,698,634	197,911	144
MS-13	Luzerne	5A		32	3			35	44,543	6,503,636	185,839	146
MS-14	Dauphin	5A		20				20	19,157	2,803,860	140,113	146
MS-15	Butler	5A		68				68	66,845	9,821,302	144,431	147
MS-16	Westmoreland	5A		15	13	8		36	46,095	6,855,424	190,433	149
MS-17	Lackawanna	5A		12	12	8	4	36	50,019	7,560,000	210,000	151
MS-18	Northumberland	5A		32				32	38,240	5,789,694	180,933	151
MS-19	Centre	5A		37	11			48	57,959	8,781,136	182,910	152
MS-20	Lackawanna	5A		44	4			48	49,460	7,493,999	156,115	152
MS-21	Allegheny	5A		30	34			64	69,605	10,837,117	169,333	156
MS-22	Dauphin	5A		43	11			54	51,319	8,411,465	155,736	164
MS-23	Montgomery	4A		60				60	58,681	9,643,959	160,733	164
MS-24	Adams	5A		39	4			43	50,532	8,515,443	198,031	169
MS-25	Clarion	5A		48				48	53,668	9,090,720	189,330	169
MS-26	Allegheny	5A		40	6			46	56,969	10,124,143	220,000	178
MS-27	Allegheny	5A		28	8			36	42,500	7,582,274	210,611	178
MS-28	Chester	4A		47	13			60	61,551	10,982,435	183,000	178
MS-29	Delaware	4A		38	3			41	47,797	8,539,207	208,233	179
MS-30	Allegheny	5A		52	8			60	63,861	11,647,354	194,133	182
MS-31	Philadelphia	4A		37	44			81	93,000	17,635,125	217,733	190
MS-32	Crawford	5A		36	4			40	38,953	7,552,475	188,833	194
MS-33	Westmoreland	5A		47				47	49,080	9,801,657	208,533	200
MS-34	Bucks	4A		56	10			66	61,576	12,448,922	188,600	202
MS-35	Lycoming	5A		23	11			34	35,437	7,169,151	210,833	202
MS-36	Philadelphia	4A		61				61	60,137	12,416,322	203,533	206
MS-37	Bradford	5A		40	10			50	56,580	11,852,026	237,000	209
MS-38	Philadelphia	4A		58	4			62	57,653	12,079,768	194,833	210
MS-39	Philadelphia	4A		52				52	46,619	9,903,739	190,433	212
MS-40	Philadelphia	4A		60				60	56,672	12,174,301	202,933	215
MS-41	Philadelphia	4A		45				45	48,351	10,464,750	232,500	216
MS-42	Montgomery	4A		50				50	42,265	9,236,729	184,733	219
MS-43	Allegheny	5A		29	4			33	37,592	8,284,054	251,033	220
MS-44	Philadelphia	4A		46	4			50	46,640	10,701,164	214,033	229
MS-45	Philadelphia	4A		53				53	50,312	11,711,200	220,933	233
MS-46	Philadelphia	4A		34	11			45	42,520	10,560,747	234,633	248
MS-47	Philadelphia	4A		24				24	24,284	6,040,593	251,633	249
MS-48	Philadelphia	4A		60				60	65,340	17,249,402	287,433	264
MS-49	Luzerne	5A		36				36	27,296	7,653,000	212,533	280
MS-50	Philadelphia	4A		48				48	46,000	12,915,822	269,033	281

YEAR 2 A NATIONAL Net-Zero-Energy Initiative by 2030
2016

CONSTRUCTION COST OF PROPOSED PROJECTS TO PHFA 2016

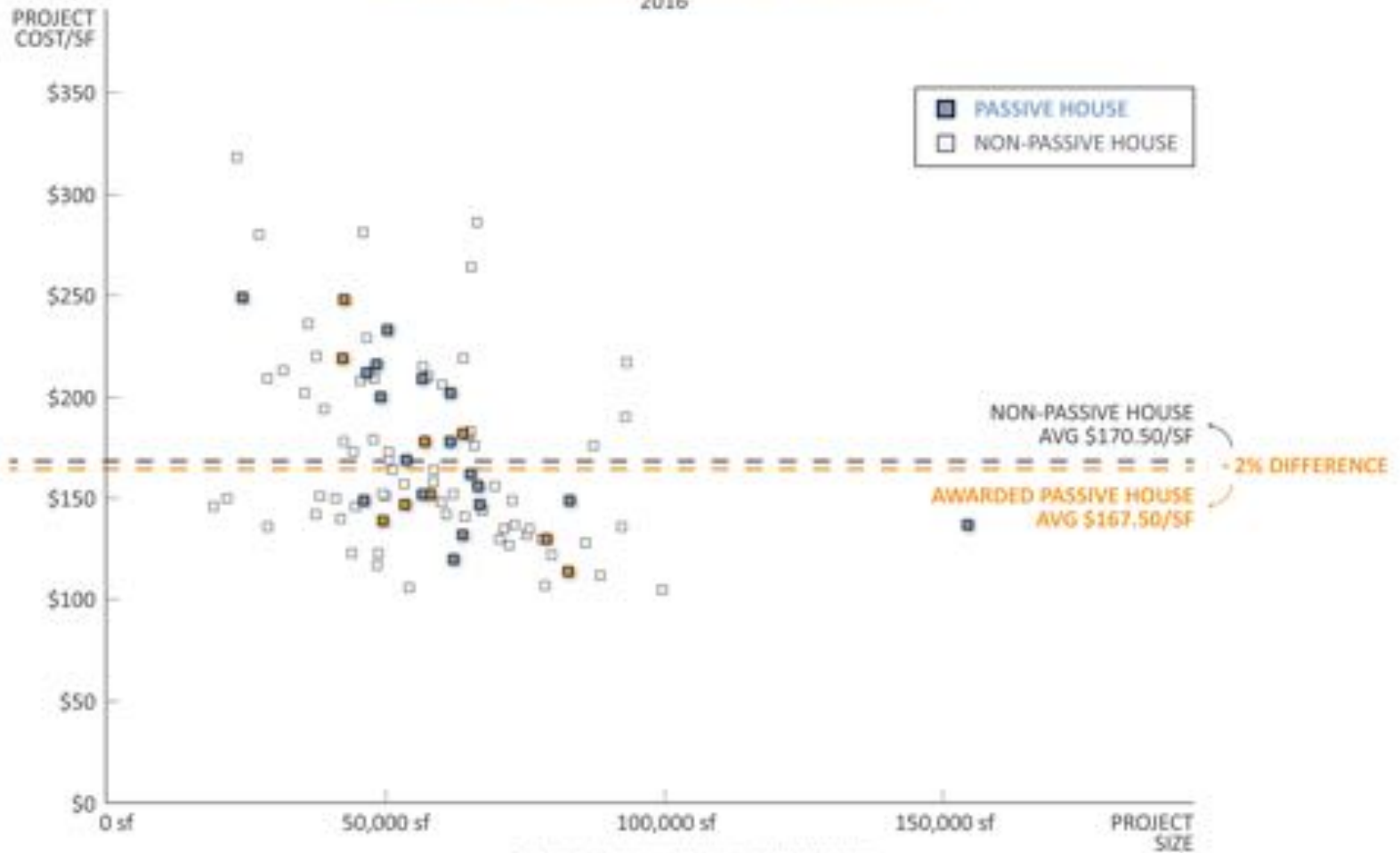

DATA SOURCE: PENNSYLVANIA HOUSING FINANCE AGENCY

© Onion Flats 2016. Prepared by NK Architects



Morningside Crossing
Pittsburgh, PA
46 Units



Glassport
Glassport, PA
55 Units



Mt. Lebanon Sr. Housing
Pittsburgh, PA
60 Units



Roxbury Place
Johnstown, PA
43 Units



Westminster @ Windy
Phillipsburg, PA
48 Units



Parade St. Commons
Erie, PA
40 Units



The Willows
Landisville, PA
60 Units



Muncy Green
Muncy, PA
60 Units



Montgomery Park
Norristown, PA
50 Units



Anthony Wayne Senior
Phila, PA
45 Units



10 Passive House Projects **COMPLETE**

8 PH projects Funded

Construction Cost Summary of 2018 PHFA Applications												
Ref. No.	County	Climate Zone	Units by BR Qty					Total Units	Resid. Bldg Area	Resid Constr \$	\$ / Unit	\$ / SF
			0	1	2	3	4+					
SF-01	York	5A			10	13	23	44,064	4,475,121	194,570	102	
SF-02	Dauphin	5A				22	22	44	66,603	8,409,248	191,119	126
SF-03	York	5A		6	23	24	3	56	72,013	9,258,025	165,322	129
SF-04	Berks	5A			24	22		46	66,030	8,557,500	186,033	130
SF-05	Lebanon	5A		18	26	16		60	76,101	10,333,056	172,218	136
SF-06	Franklin	5A			7	25		32	54,375	8,150,464	254,702	150
SF-07	Philadelphia	4A		2	5	11	2	20	29,503	4,490,975	224,549	152
SF-08	Lackawanna	5A		12	12	8	4	36	50,019	7,805,595	216,822	156
SF-09	Franklin	5A		6	21	21		48	66,583	10,727,005	223,479	161
SF-10	Multiple Co's	5A		52				52	52,330	8,909,580	171,338	170
SF-11	York	5A		18	9	7		34	35,636	6,396,969	188,146	180
SF-12	Allegheny	5A		47	10			57	48,150	9,106,659	159,766	189
SF-13	Westmoreland	5A		3	6	9		18	20,489	4,108,548	228,253	201
SF-14	Allegheny	5A		4	7	9		20	26,198	5,407,155	270,358	206
SF-15	Armstrong	5A			24			24	29,147	6,230,195	259,591	214
SF-16	Susquehanna	6A		34	2			36	31,103	7,031,404	195,317	226
SF-17	Philadelphia	4A			17	16	2	35	45,476	10,281,980	293,771	226
SF-18	Philadelphia	4A		11	10	12		33	34,388	8,875,449	268,953	258
SF-19	Philadelphia	4A		28	12			40	46,232	12,214,948	305,374	264
SF-20	Philadelphia	4A		12	18	11	9	50	71,903	21,367,901	427,358	297

Construction Cost Summary of 2018 PHFA Applications												
Ref. No.	County	Climate Zone	Units by BR Qty					Total Units	Resid. Bldg Area	Resid Constr \$	\$ / Unit	\$ / SF
			0	1	2	3	4+					
MS-01	Erie	5A			45			45	100,201	8,587,936	190,843	86
MS-02	Lancaster	5A		44	18			62	76,045	8,306,338	133,976	109
MS-03	Lancaster	5A		45	15			60	68,993	8,544,047	142,401	124
MS-04	Cumberland	5A		14	12	16		42	49,581	6,440,993	153,357	130
MS-05	Berks	5A		45	12			57	59,916	7,892,757	138,469	132
MS-06	Westmoreland	5A		15	13	8		36	46,095	6,087,669	169,102	132
MS-07	Fayette	5A		18	18			36	42,820	5,679,247	157,757	133
MS-08	Dauphin	5A		35	2			37	43,928	5,896,750	159,372	134
MS-09	Bradford	5A		63	12			56	63,759	8,603,563	153,635	135
MS-10	Allegheny	5A		30	10			40	54,495	7,335,570	183,394	135
MS-11	Lancaster	5A		46	6			52	94,440	12,791,060	245,982	135
MS-12	Centre	5A		16	34			50	60,599	8,371,068	167,421	138
MS-13	Montgomery	4A		42	14			56	60,166	8,477,023	151,375	141
MS-14	Luzerne	5A		32	3			35	44,543	6,416,086	183,317	144

Ref. No.	County	Climate Zone	Units by BR Qty					Total Units	Resid. Bldg Area	Resid Constr \$	\$ / Unit	\$ / SF	
			0	1	2	3	4+						
MS-14	Luzerne	5A			32	3			35	44,543	6,416,086	183,317	144
MS-15	Clinton	5A			28	4			32	37,454	5,470,901	170,966	146
MS-16	Dauphin	5A			20	29			49	53,976	8,066,609	164,625	149
MS-17	Washington	5A			21	25			46	53,310	8,000,885	173,932	150
MS-18	Franklin	5A			36	4			40	54,596	8,326,929	208,173	153
MS-19	Chester	4A			57	3			60	60,931	9,310,170	155,170	153
MS-20	Northumberland	5A			32	4			36	43,826	6,998,140	194,393	160
MS-21	York	5A			16	26	8		50	63,425	10,125,538	202,511	160
MS-22	Allegheny	5A			27	18	9		54	64,875	10,797,000	199,944	166
MS-23	Westmoreland	5A			43	4			47	50,680	8,439,569	179,565	167
MS-24	Clearfield	5A			24	6			30	35,984	6,065,728	202,191	169
MS-25	Beaver	5A			44	8			52	57,297	9,797,660	188,417	171
MS-26	Northampton	5A			12	33	15		60	60,212	10,329,351	172,156	172
MS-27	Montgomery	4A			60				60	61,110	10,869,266	181,154	178
MS-28	Dauphin	5A			38	11			49	48,638	8,730,738	178,178	180
MS-29	Montgomery	4A			66	8			74	74,468	13,541,230	182,990	182
MS-30	Clarion	5A			39	3			42	48,847	8,988,545	214,013	184
MS-31	Philadelphia	4A			28	13			41	49,625	9,204,879	224,509	185
MS-32	Lehigh	5A			27	13			40	40,937	7,663,199	191,580	187
MS-33	Allegheny	5A			31	3	1		35	46,015	8,714,276	248,979	189
MS-34	Butler	5A			30	13	1		44	50,825	9,697,495	220,398	191
MS-35	Delaware	4A			58				58	57,365	11,293,126	194,709	197
MS-36	Bucks	4A			68	1			69	62,844	12,503,344	181,208	199
MS-37	Delaware	4A			38	3			41	43,515	8,746,409	213,327	201
MS-38	Blair	5A			43	2			45	47,642	9,595,216	213,227	201
MS-39	Tioga	5A			34	6			40	32,800	6,591,082	164,777	201
MS-40	Lycoming	5A			18	6			24	26,749	5,419,721	225,822	203
MS-41	Philadelphia	4A			44				44	46,306	9,443,528	214,626	204
MS-42	Philadelphia	4A			52				52	46,619	9,893,465	190,259	212
MS-43	Crawford	5A			37	2			39	40,256	8,580,594	220,015	213
MS-44	Allegheny	5A			46				46	48,600	10,405,629	226,209	214
MS-45	Luzerne	5A			36				36	36,784	8,100,000	225,000	220
MS-46	Philadelphia	4A			11	11	8		30	39,650	8,957,527	298,584	226
MS-47	Allegheny	5A			19	13	11		43	41,797	9,558,272	222,285	229
MS-48	Philadelphia	4A			46	4			50	48,315	11,197,257	223,945	232
MS-49	Philadelphia	4A			60				60	57,672	13,556,215	225,937	235
MS-50	Philadelphia	4A			45				45	48,351	11,428,626	253,969	236
MS-51	Philadelphia	4A			37	10			47	50,527	12,095,152	257,344	239
MS-52	Philadelphia	4A			32	6	6		44	44,889	10,869,638	247,037	242
MS-53	Philadelphia	4A			24				24	24,284	6,253,770	260,574	258
MS-54	Allegheny	5A			30	20			50	37,290	9,905,483	198,110	266
MS-55	Philadelphia	4A			20	30			50	46,110	12,718,548	254,371	276
MS-56	Philadelphia	4A			48				48	45,000	14,294,705	297,806	318
MS-57	Philadelphia	4A			46				46	31,878	11,701,929	254,390	367

YEAR 3-4 A NATIONAL Net-Zero-Energy Initiative by **2030**
2017-18

CONSTRUCTION COST OF PROPOSED PROJECTS TO PHFA

2018

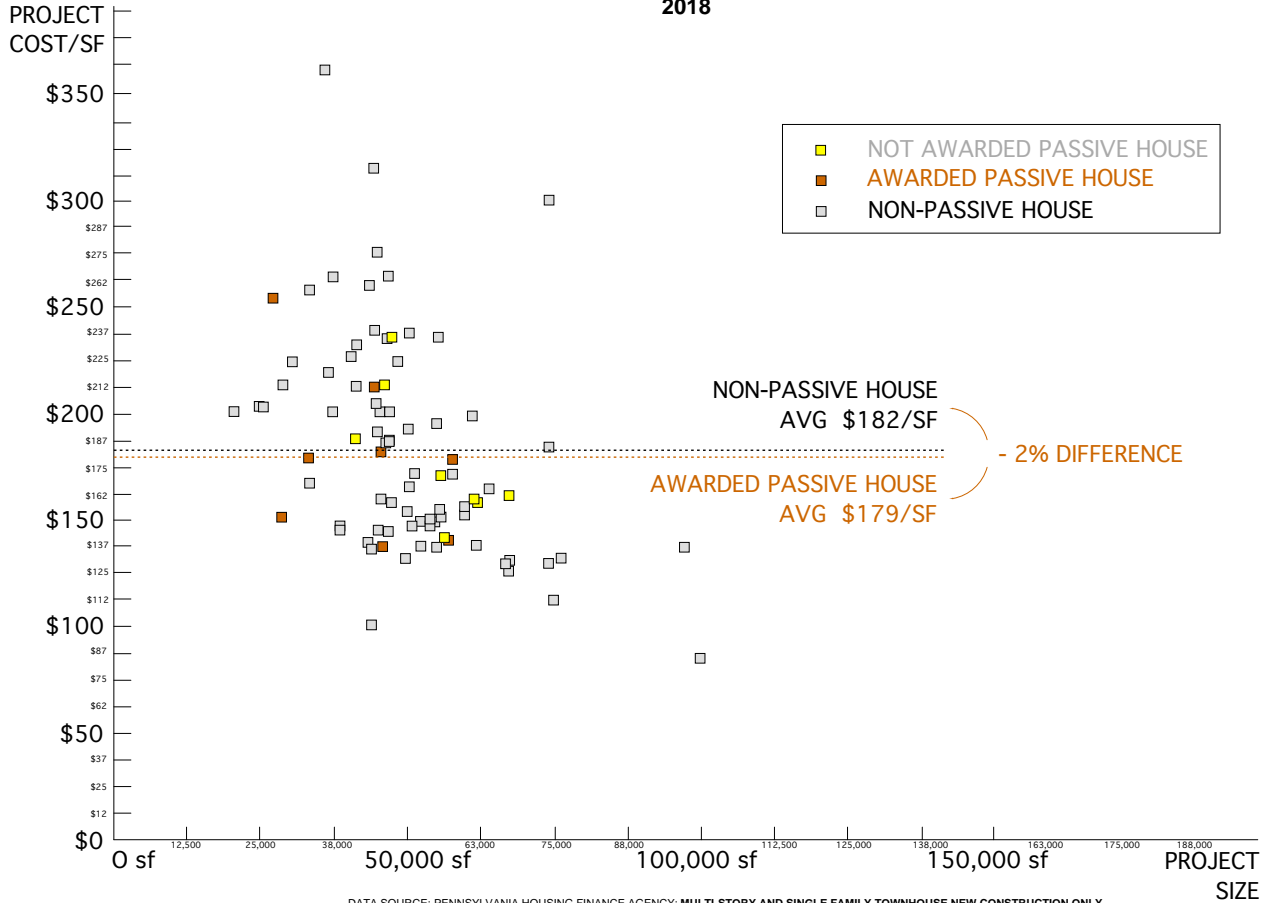

DATA SOURCE: PENNSYLVANIA HOUSING FINANCE AGENCY: MULTI-STORY AND SINGLE FAMILY TOWNHOUSE NEW CONSTRUCTION ONLY

YEAR 3-4 A NATIONAL Net-Zero-Energy Initiative by **2030**
2017-18



THE WHITEHALL: missionfirsthousing.org

2017

49 units of Veteran housing

2015 Final Design – 49 Units

- Wall:
 - Adam Cohen's BuildSmart panelized wall system
 - 2x6 stud with Dense-Pack Cellulose (R3.8/inch) in cavity, OSB, 3.5" EPS, Zip Panel
 - **TOTAL R33**
 - Windows: Come pre-installed in wall system: Klearwall Future Proof, glass has Uvalue of .11 BTU/hr/ft2, with SHGC of .61 (window muntins reduce SHGC to .57)
- Slab:
 - Adam Cohen BuildSmart preformed EPS slab/foundation system, thermal bridge free.
 - **TOTAL R26.3**
- Roof:
 - Roof truss with 18" of Cellulose
 - ZIP panel as Air Barrier underside of truss to be fully taped at joints and to Zip panel at wall.
 - A service cavity below the Air barrier with Chicago grid will allow for lighting, wiring sprinklers, etc without puncturing the Air Barrier
 - **TOTAL: R50**
- Domestic Hot water:
 - State 50 gallon Heat Pump Water Heater (HPWH) with a COP of 2.75, one per unit
- Ventilation:
 - Three Ultimate Aire 2000DX ERV centralized and ducted system for all of the 49 apartments and corridors, ancillary areas and Community Room. The ERV should be located in attic space.
 - Addressed discrepancy between PH and Energy Star with respect to Sach requirement by ducting the kitchen hood directly to outside with magnetic damper. Flow rates for units:
 - 1 bdrm units: 47cfm
 - 2bdm units: 71 cfm
 - 3 bdrm units: 83 cfm
- Heating/Cooling:
 - Fujitsu ducted mini-splits within each apartment with ganged condensers at grade. They have an HSPF between 12.2-11.5 BTU/h/W and a SEER of 19.7-21.5 depending on size of units.
- Laundry
 - 5 commercial washers and dryers in common laundry room
 - Gas dryers vented to outside with magnetic dampers and gas DHW dedicated in room.
- Construction costs: Not sure right now but originally at \$148sf
- CHALLENGES
 - shifting from decentralized Zehnder units, one per unit, to centralized US manufacturer. Took hit in performance.
 - Shift to BuildSmart wall/foundation system but I think good move for overall coordination. Taking risk, however, because this has not been tested.

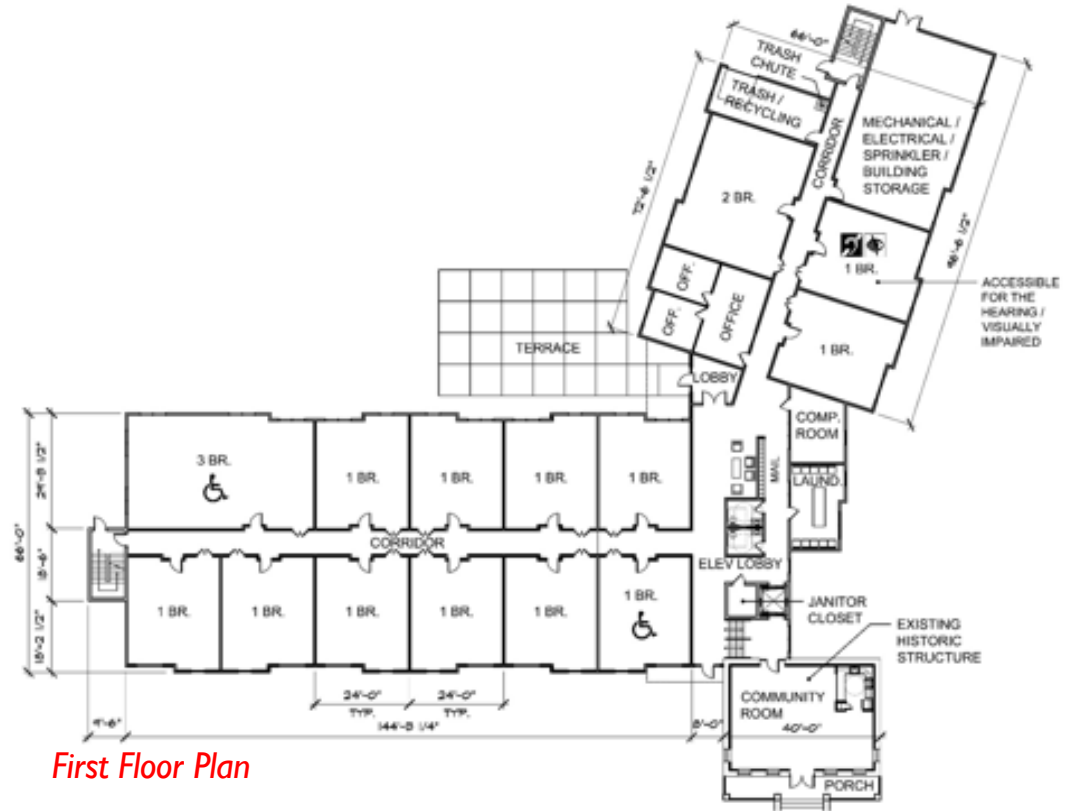
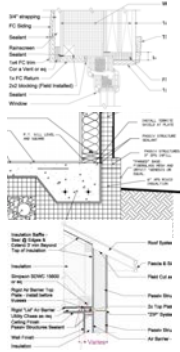

First Floor Plan



THE WHITEHALL: missionfirsthousing.org

2017

49units of Veteran housing



THE WHITEHALL: missionfirsthousing.org

2017

49units of Veteran housing



THE WHITEHALL: missionfirsthousing.org

2017

49 units of Veteran housing

PRE-DRYWALL BLOWER DOOR TEST
September 26, 2016

.5 ACH50



FINAL DRYWALL BLOWER DOOR TEST
April 17, 2017

.42 ACH50



The Whitehall Utility Cost Comparison

	1 BR	2 BR	3 BR
Housing Authority Allowances	\$103.00	\$138.00	\$169.00
Calculated Passive House	\$42.37	\$60.45	\$80.97



Impact of Utility Costs on Operating Budget

	Housing Authority Allowances	Calculated Passive House
TTP For All Units	\$545,748	\$545,748
Less Utilities	\$64,548	\$27,372
Rent	\$481,200	\$518,376
Operating Costs	\$382,084	\$382,084 *
Net Income	\$99,116	\$136,292



CHIP: “*Understates the case: operating costs include common area utilities, which are lower in Passive House construction than in traditional construction. So the operating costs in the Housing Authority scenario would be higher, meaning that the actual difference in Net Income is higher than shown”

Impact of Utility Costs on Operating Budget

	Housing Authority Allowances	Calculated Passive House
Net Operating Income	\$99,116	\$136,292
Debt Coverage Ratio*	1.8	1.8
Payment (NOI/DCR)	\$55,064	\$75,718
Max Mortgage (30 yrs @ 5.5%)	\$800,000	\$1,100,000
*1.07 in Year 15		



CHIP: "Passive House lets you borrow/leverage more money to build more housing."

Impact of Utility Costs on Operating Budget

	Housing Authority Allowances	Calculated Passive House
Total Development Cost	\$12,750,000	\$12,750,000
LIHTC Equity	\$11,000,000	\$11,000,000
Soft Debt/Grants	\$450,000	\$450,000
Mortgage	\$800,000	\$1,100,000
Total	\$12,250,000	\$12,550,000
Deferred Fee Required	\$500,000	\$200,000
Gross Fee	\$1,500,000	\$1,500,000
Net Fee	\$1,000,000	\$1,300,000



CHIP: "We're a nonprofit, which means we don't put the net fee in our pockets. We put that money into new developments. Higher net fees mean we can house more people."



*Opening Day
June 14, 2017*

THE WHITEHALL: missionfirsthousing.org

2017

49 units of Veteran housing

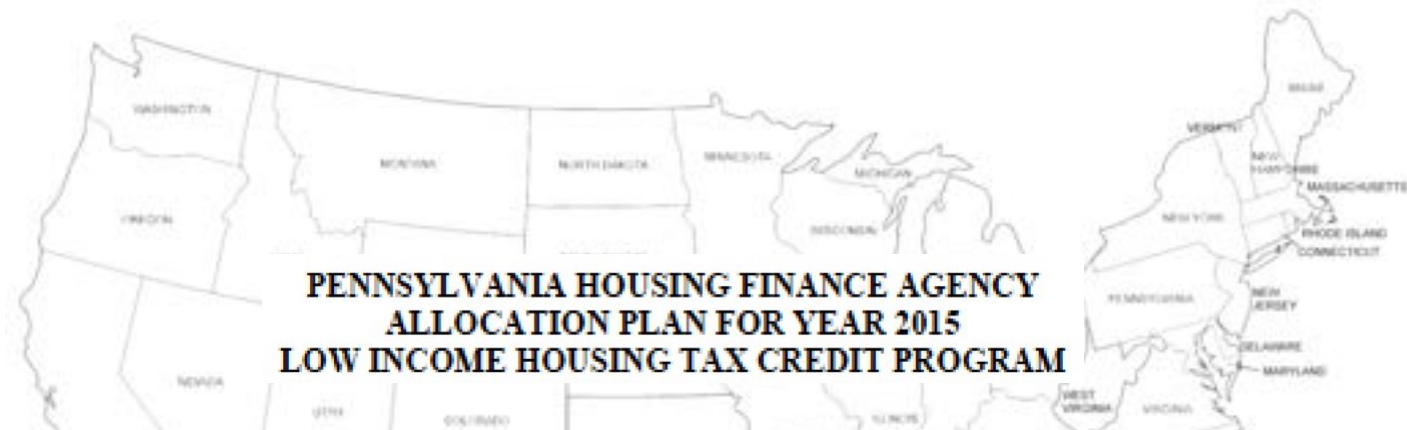

- **Energy Efficiency Goals – 10 points may be awarded to those developments which meet Passive House Certification (nationally or internationally) for energy efficiency. (See Multifamily Housing Application and Guidelines and www.passivehouse.us or <http://passiv.de/en/> for additional guidance.)**





40 State Housing Finance Agencies
Engaged to replicate PHFA strategy

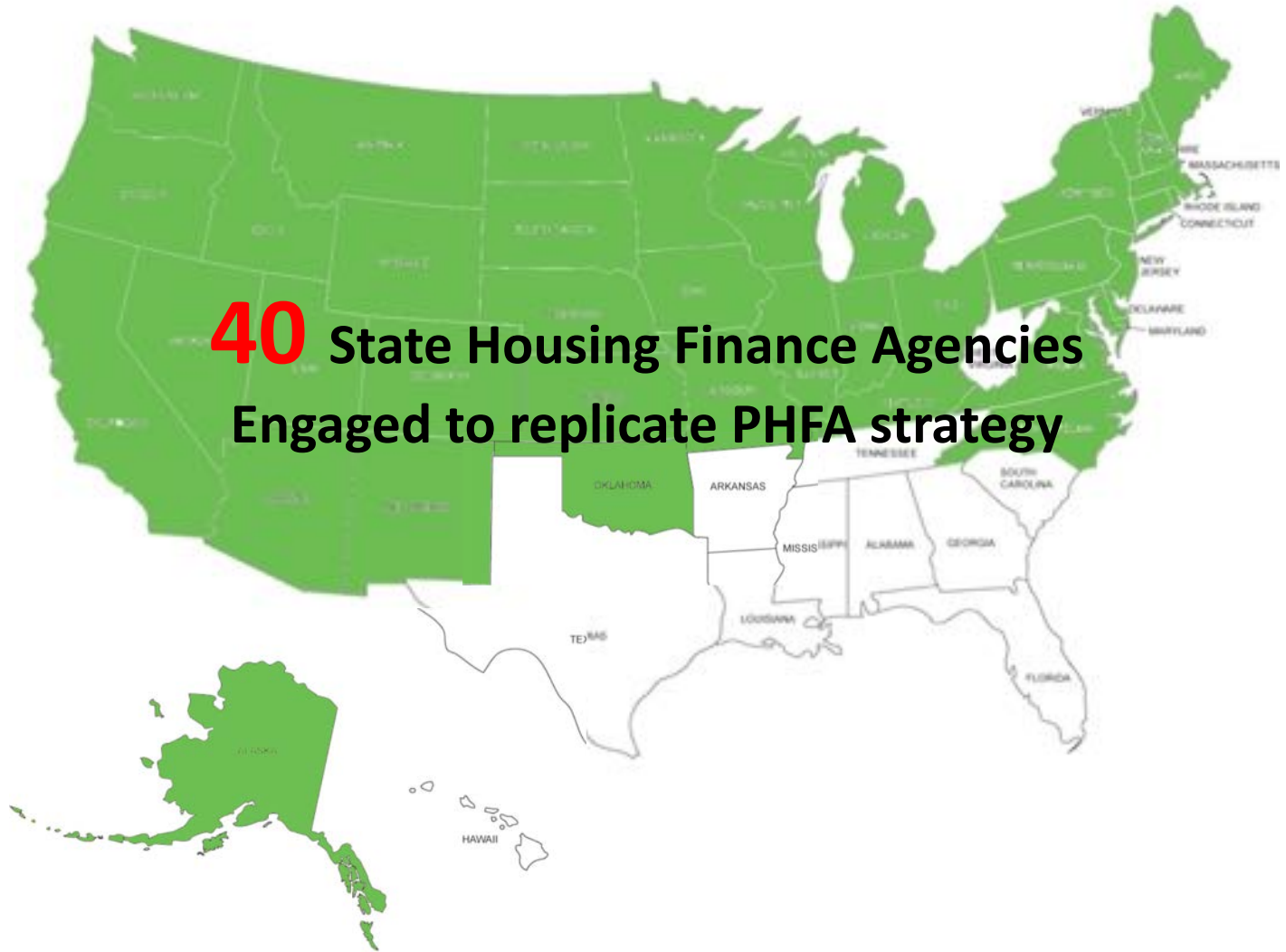

40 State Housing Finance Agencies
Engaged to replicate PHFA strategy

18 COMMITTED!!

- 1 California
- 2 Connecticut
- 3 District of Columbia
- 4 Delaware
- 5 Idaho
- 6 Illinois
- 7 Maryland
- 8 Massachusetts
- 9 Montana
- 10 New Hampshire
- 11 New Jersey
- 12 New York
- 13 Ohio
- 14 Pennsylvania
- 15 Rhode Island
- 16 South Dakota
- 17 Vermont
- 18 Virginia



Virginia Housing Low Income Housing Tax Credit Manual 2022



Version: 2022
January 1, 2022

Baseline

10 Points

10 "Future Points"

Baseline requirement for all tax credit developments in Virginia

Certification must be completed by a third party, independent, non-affiliated certified RESNET rater. All raters must submit to the owner, to be included in the application, a signed Virginia Housing RESNET Rater form and a HERS report from an energy rating software program listed on the National Registry of Accredited Rating Software Programs. All raters certifying a property must be authorized to conduct business in Virginia.

New Construction

Must become Energy Star Certified using appropriate program for development as defined annually by Energy Star- Reservation application will include the Virginia Housing RESNET Certification and HERS report. 8609's will not be issued until the Energy Star Certification is presented to the Virginia Housing Tax Credit Allocation Department.

Rehabilitation-

30% performance increase over existing, based on HERS Index or, must evidence a HERS Index of 80 or lower-Reservation application will include the Virginia Housing RESNET Certification and HERS report. 8609's will not be issued until a notarized final Virginia Housing RESNET Certification is received.

Additional Certification- Choose one: All requirements must be verified by a third party independent non-affiliated certified RESNET rater, rater must be listed by a provider on the Virginia Housing certified Provider list. All Raters must submit with the application a signed Virginia Housing RESNET Rater form. All raters certifying a property for Virginia LIHTC must be authorized to conduct business in Virginia and certified to complete all information for chosen additional certification. Chosen certification and notarized Final Virginia Housing RESNET Certification must be received prior to 8609's issuance or penalties will be applied.

1. LEED Certification- Certification must be presented to Virginia Housing
2. Earth Craft Certification Gold or above- Certification must be presented to Virginia Housing
3. Enterprise Green Communities Certification- Certification must be presented to Virginia Housing
4. National Green Building Standard- Silver or above- Certification must be presented to Virginia Housing

Future Points

Points will be awarded to a developer that can provide certification for meeting one of the following. A document will be issued to the owner entity of the development to be used in one future application. The document is valid for 3 years and is non-transferrable.

1. Passive House-points for future applications after proof a development has become Passive House certified.

2. Zero Energy Ready Homes-points for future application after proof a development has received the Zero Energy Ready homes certification from Department of Energy.

PENNSYLVANIA

NEW YORK



NYC: *The House at Cornell Tech, Knickerbocker Commons, Sendero Verde*

18 COMMITTED



NEW HAMPSHIRE: *Gilford Village Knolls*



SOUTH DAKOTA: *Student Passive House Project and Copper Pass Apartments*



OHIO: *Fairwood Commons*



RESEARCH ON PASSIVE HOUSE IN QAPs

- States with differentiation from LEED get more PH projects
 - ✓ PA 23 projects (10 pt. bonus/150)
 - ✓ CT 6 projects (3 pt. bonus/104)
 - ✓ VT 1 project (1 of 30 checks)
 - ✓ SD 1 project (\$500K bonus)
 - ✓ MA ~12 projects (2 points/182)- but also \$3K per unit MassSave incentive
- Having PH as equivalent to LEED is not effective way to incentivize PH
 - ✓ 12 States- no PH projects



....14 ON THEIR WAY!!

- WASHINGTON
- OREGON
- NEVADA
- UTAH
- MINNESOTA
- IOWA
- MISSOURI
- OKLAHOMA
- WISCONSIN
- MICHIGAN
- INDIANA
- KENTUCKY
- MAINE
- ALASKA



WASHINGTON

OREGON

NEVADA

....14 ON THEIR WAY!!



Vermont: Elm Place
WISCONSIN



Oregon: The Orchards at Orenco



Maine: Bayside Anchor Passive House
Village Centre Passive House



ALASKA
Minnesota: West Side Flats



Missouri: Second and Delaware, Kansas City





GREEN BUILDING UNITED
2021 New Gravity

PASSIVE
HOUSE
ACCELERATOR



★ Worth 5 LU|HSW, 4 GBCI CE, and 4 CPHC CEUs

2021 New Gravity - Accelerated Edition

Wed, 7/21/2021 - Thu, 7/22/2021 - 7:00pm - 9:00pm

Online

AFFORDABLE HOUSING

AFFORDABLE HOUSING



Architects, Engineers, Builders

AFFORDABLE HOUSING



Architects, Engineers, Builders



MARKET-RATE HOUSING

*Catalyst for radical and significant transformation of the
HOUSING INDUSTRY.....*

AFFORDABLE HOUSING



Architects, Engineers, Builders



MARKET-RATE HOUSING

Lessons Learned

1. Encourage Prefabrication, it **WORKS!**
2. Encourage Vertical Integration, it **WORKS!**
3. **KISS: Keep It Simple Stupid**
4. Educate tenants/owners on systems and utilities
5. Leverage utility savings to build more housing!!
6. HFA's should incentivize Passive House **MORE** than other sustainable standards
7. Require **ALL-ELECTRIC BUILDINGS**
8. Include PV + PH as part of your capital stack
9. **Policy over Pilot Projects!**

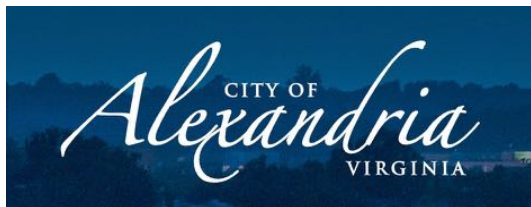

**THANK
YOU**

Tim McDonald
tim@onionflats.com
215.783.5591

